Thank you for choosing SAIC MAXUS Automotive Co.,Ltd. May our products and services bring fresh joy to your life!

Please take time to read and understand this Handbook and other publications supplied with it. Thus you can familiarize yourself with the vehicle and enjoy a driving experience with comfort, safety as well as economy.

This Driver's Handbook will provide you with the information necessary for getting familiar with your vehicle, including how to drive the vehicle, how to carry out routine maintenance checks, and what to do in an emergency.

This Handbook contains the latest information upon the time of printing and all modifications, interpretations and explanations should be reserved by the company. Based on the consideration that the products will be upgraded or in any other way(s) modified constantly, the company reserves the right to apply these changes mentioned here before without notice when the Handbook has been hereby printed and published and will accept no liability.

This Handbook is an indispensable part of the vehicle. If you want to sell the vehicle, please remember to provide the new owner with this Handbook.

Special Announcement

Driver's Handbook and Warranty & Service Handbook specify the agreement between the company and the user on establishment and termination of rights and obligations concerning the quality warranty and after-sales service of product. Please be sure to read the Driver's Handbook and Warranty & Service Handbook carefully before using the product. If any damage is caused by misuse, neglect, incorrect operation or unauthorized refit, the user will have no right of claim, and any warranty request will be refused by SAIC MAXUS Automotive Co.,Ltd Service Dealer(hereinafter referred to as "Service Dealer").

Unauthorized re-production of this Handbook, whether electrically, physically or in any other way, and/or storing the Handbook in any inquiry system of any form or type shall not be permitted.

Wish you a pleasant driving!

SAIC MAXUS Automotive Co.,Ltd. Address: #2500, Jun Gong Road, Yang Pu District, Shanghai Postcode: 200438

SAIC MAXUS Automotive Co.,Ltd reserves the final right to interpret this Handbook

Contents

Perface	1	Headrest.....	25
Introduction	1	Passenger restraint system	25
About this handbook.....	1	Sitting correctly.....	25
Indicative information	1	Seat belts	26
Precautions	3	Seat belt pretensioner	29
Dangerous substances.....	3	Airbags	30
Children/Animals	3	Child restraints (not supplied with the vehicle).....	39
Personal safety.....	3	Instruments and controls	40
Vehicle identification	4	Instrument cluster	41
Vehicle identification number (VIN).....	4	Tachometer.....	41
Engine number	4	Engine coolant temperature gauge	41
VIN plate.....	5	Speedometer.....	41
1 Before You Drive	7	Fuel gauge	42
Keys	8	Message center	42
Remote key with PEPS	8	Alarm messages.....	44
Extension/retraction of mechanical key portion of the remote key ("mechanical key portion" for short).....	8	Service interface reminders.....	45
Replace the battery in the remote key with PEPS.....	9	Tire pressure monitoring system	46
Door locks	10	Warning lights and indicators	46
To protect your vehicle against theft.....	10	Direction indicator.....	46
Central door locking system.....	11	Headlight main beam indicator.....	46
Side load door(s).....	15	IHC (Intelligent High Beam Control) indicator	46
Tail door.....	16	Front fog light indicator	47
Child proof locks.....	18	Rear fog light indicator	47
Windows	19	Position light indicator	47
Power window	19	Engine immobilizer warning light.....	47
Windshield heating.....	21	TPMS warning light	47
Seats	22	Fuel filter water level warning light	47
Driver and front occupant seat adjustment.....	22	Glow plug indicator.....	47
		Engine malfunction warning light.....	48
		Emission MIL.....	48

Contents

DPF (Diesel Particulate Filter) warning light.....	48	Combination light control switch.....	55
Oil pressure warning light.....	48	Instrument cluster switch.....	57
Battery no-charge warning light.....	48	Headlamp leveling switch.....	57
Engine coolant temperature warning light.....	49	Instrument cluster illumination control switch.....	57
Low fuel warning light.....	49	EPB (Electronic Parking Brake) switch.....	58
Urea warning light.....	49	AUTO HOLD switch.....	58
Airbag warning light.....	49	MODE (driving mode) switch.....	59
Seat belt warning light.....	50	DPF one-touch regeneration switch.....	60
Brake system warning light.....	50	SOS alarm switch.....	60
ABS (Anti-lock Braking System) warning light.....	50	Hazard warning light switch.....	61
EBD (Electronic Brake Distribution) warning light.....	51	Master power switch.....	61
ESP (Electronic Stability Program) indicator.....	51	Switches on steering column and steering wheel.....	62
ESP (Electronic Stability Program) OFF indicator.....	51	Combination light control & direction indicator light stalk switch ..	62
EPB (Electronic Parking Brake) indicator.....	51	Wiper and washer lever switch.....	65
EPB (Electronic Parking Brake) malfunction indicator.....	51	Instrument cluster selection and cruise switch.....	67
AUTO HOLD indicator.....	52	Voice control, bluetooth phone, steering wheel heating switch....	68
EPS (Electric Power Steering) system MIL.....	52	Horn.....	69
Cruise control indicator.....	52	Steering wheel adjustment.....	70
FCW (Forward Collision Warning) warning light/AEB (Automatic Emergency Braking) warning light.....	52	Heating, ventilation and air conditioning (HVAC).....	71
LDW (Lane Departure Warning)/LKA (Lane Keep Assist) /ELK (Emergency Lane Keeping) warning light.....	52	Front ventilation.....	71
SLIF (Speed Limit Information Function) indicator.....	53	Manual A/C control panel.....	72
Speed limit indicator.....	53	Electric A/C control panel.....	74
Normal (Normal mode) indicator.....	53	Air conditioning operating tips.....	76
ECO (Economic mode) indicator.....	53	Rearview mirrors.....	77
POWER (Sport mode) indicator.....	54	Exterior rearview mirrors - power adjustment.....	77
Trailer indicator.....	54	Exterior rearview mirrors - manual adjustment.....	77
Auto stop/start system indicator.....	54	Foldable rearview mirrors.....	78
Electric step indicator.....	54	Interior rearview mirrors.....	78
Exterior light switch.....	55	Interior equipment.....	79

Contents

Roof vanity lamp.....	79	Stopping	93
Ashtray	80	Auto stop/start system	94
12V power socket.....	80	Basic service conditions.....	94
USB ports.....	81	Stopping and starting the engine.....	94
Cup holder.....	82	Note.....	95
Glove box	82	Driving	96
Sun visors.....	83	Running-in of new vehicle	96
Glasses box.....	83	Driving	96
Vehicle tools	84	Ramps and ferries.....	97
Electric step.....	84	Catalytic converter	98
Entertainment system.....	85	Fuel	102
Precautions before use	85	Refueling	102
2 Starting and Driving	87	Fuel filler cap.....	103
Starting and driving	88	Saving fuel.....	103
Ignition switch	88	Precautions for cold weather.....	104
Keyless start.....	88	Fuel hose.....	104
Keyless start system	90	Urea.....	105
Keyless unlocking.....	90	Urea filling	105
Keyless locking.....	90	Manual transmission	106
Keyless start.....	90	Gear shifting	106
Backup starting.....	91	Electric power steering unit.....	107
Emergency Start and Shutdown.....	91	Brake system	108
Engine immobilizer	92	Service brake	108
Key	92	ABS (Anti-lock Brake System).....	109
Enable/disable.....	92	ESP (Electronic Stability Program).....	111
Starting/stopping the engine	92	EPB (Electronic Parking Brake)	112
Starting	92	AUTO HOLD	114
Warm-up.....	93	Warning light	115
Self-protection mode	93	Cruise control system	116

Contents

Cruise control settings.....	116	Instructions of trailer towing.....	146
Terminating cruise control	118	Recommended towing weight.....	150
Clearing speed memory	118	Installation of trailer device.....	151
Parking assist system	118	Maintenance.....	151
Parking sensor	118	3 Emergency Troubleshooting	153
Front and rear sensors.....	120	Hazard lamp.....	154
Parking camera	122	Warning triangle	154
360° around-view system.....	123	Jump start.....	155
Driver assistance system	124	Battery disconnection.....	155
Camera.....	124	Jump start.....	156
Radar.....	125	Replacing wheel	157
FCW and AEB (Forward collision assist)	126	Jack.....	157
LDW (Lane Departure Warning).....	128	Spare tire.....	157
LKA (Lane Keeping Assist)	130	Replacing tire	159
ELK (Emergency Lane Keeping).....	132	Towing vehicle	163
SLIF (Speed Limit Information Function).....	134	Towing hitch.....	163
IHC (Intelligent High beam Control)	135	Towing	164
Blind spot assist	136	Draining fuel filter	164
RCTA (Rear Cross Traffic Alert).....	138	Replacing fuse	165
DOW (Door Open Warning)	139	Driver compartment fuse box	166
Driver monitoring system	141	Front compartment fuse box	168
Tires	143	Battery fuse box	172
Winter tires	143	Fuse replacement.....	172
Anti-skid chain	144	Replacing bulbs.....	173
Loading.....	145	Bulb specification	173
Load carrying.....	145	4 Maintenance and Service.....	175
Hazardous loads	145	Safety.....	176
Load restraint	145	Scheduled maintenance	177
Trailer towing.....	146		

Contents

Owner's check	178	Operating in winter	191
Daily checks	178	Recharging the battery with ground equipment.....	191
Weekly checks or check before a long journey	178	Removing the battery	192
Arduous use	178	Replacing the battery	192
Front compartment hood	179	Installing the battery	192
Open hood.....	179	Tires	193
Close hood	180	Tire pressure	193
Front compartment	181	Wear indicator	194
Engine oil	181	Tire check and rotation	194
Inspection and refill	181	Other maintenance	195
Engine oil consumption	182	Vehicle cleaning	195
Coolant	183	Engine carbon deposit cleaning	195
Inspection and refill	183	Anti-corrosion of underbody	196
Brake fluid	185	Seat and trim	196
Inspection and refill	185	Door seal	196
Washer fluid	186	Window glass	196
Inspection and refill	186	Exterior trimming	196
Washer jet	187	5 General Technical Parameters	197
Adjusting and cleaning	187	Major vehicle dimension parameters	198
Wiper blade	187	Vehicle weight parameters	199
Inspection	187	Vehicle performance parameters	200
Replacement	187	Main engine parameters	201
Maintenance and service	188	Chassis technical parameters	202
Seat belt	188	Recommended fluids	203
Inspection	188	Wheel and tire	204
Maintenance and service	189	Wheel alignment parameters	205
Battery	189		
Duration of storing the vehicle.....	191		

Preface

Introduction

About this handbook

This Handbook applies to MAXUS DELIVER 7 series of Van.

Caution

The information contained in this Handbook is designed to cover more than one model option and variant, and therefore some of the items mentioned here may not apply to your vehicle.

This vehicle product follows enterprise standards Q31/011 0000019C038.

The drawings contained in this Handbook are illustrations for references only.

Indicative information

Warning



This symbol indicates that: In order to avoid the possibility of personal injury or injury to others, relevant procedures must be followed strictly and precisely.

Caution

Caution

Relevant procedures must be followed to avoid the possibility of vehicle damage.

Preface

Note

Note: *This is suggestive description which is useful for you.*

Environmental protection



Everyone is obliged to protect the environment.

This symbol intends to remind you to pay attention to environmental protection.

Arrows

 Represents described object.

 Represents its direction of motion.

See

The contents are referred by the "Section" title.

Precautions

Dangerous substances

 Many liquids and other substances used in motor vehicles are poisonous and should under no circumstances be consumed and should, so far as possible, be kept away from open wounds. These substances among others include battery acid, coolant, brake fluid, fuel, washer fluid, lubricants, refrigerant and various adhesives. Always read carefully the instructions printed on the labels or stamped on components and obey them implicitly. These instructions are for the sake of your health and personal safety. Please treat them with prudence.

For your safety, observe instructions contained in this Handbook.

Children/Animals

 Accidents and injury may be caused by unsupervised children or animals operating controls and switches fitted to your vehicle, or playing with equipment or goods being transported in it.

In order to prevent the accident or personal injury caused by a child or animal, do not leave the child or animal in the vehicle without adult supervision. Also they can become suffocated in hot weather conditions.

Personal safety

 Seat belts are fitted to all seats in your vehicle to reduce the possibility of personal injury in the event of an accident. It is required that all occupants wear seat belts. In addition, your vehicle has been installed with supplementary restraint system (SRS) comprising an airbag and a seat belt pre-tensioner, providing extra protection for the driver and front occupant.

See “Occupant restraint system” in Before You Drive section. Misuse of an air bag can result in injury.

Preface

Vehicle identification

When communicating with our Service Dealer, you should provide the vehicle identification number (VIN).

The engine number may also be required if the engine is involved during communication.

Vehicle identification number (VIN)

Vehicle identification number (VIN) on the vehicle :

- On the right front longitudinal beam of vehicle, in the front bumper mounting bracket area (seal position).
- On the VIN plate on the right side of B pillar.
- On the windshield lower cross member cover plate assembly at the left lower corner of the windshield through where the VIN can be seen easily.
- Above the right front door lock (if equipped).
- On the right fender (if equipped).
- On the hood inner panel (if equipped).
- Under the right rear floor carpet molding (if equipped).
- On the left inside wall of glove box (if equipped).
- On the right tailgate sheet metal side, located near the tailgate lock (if equipped).
- On the transmission body (if equipped).

This vehicle is equipped with an OBD data link connector, located under the left instrument cluster. You can contact Our Service Dealer to read VIN information from the electronic control unit with the special equipment.

Engine number

Engine number is printed on the bottom of front end face of cylinder block in the engine compartment (on the lower right side, viewed from the front of the vehicle).

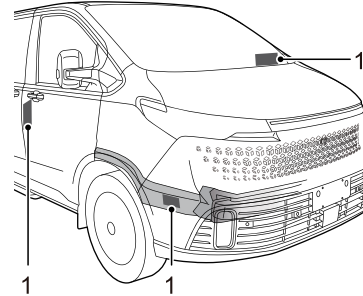

1 Vehicle identification number (VIN)

Preface

VIN plate

VIN plate may contain the following information, please refer to the actual vehicle.

- The manufacture's company name
- The whole vehicle type-approval number
- VIN
- The technically permissible maximum laden mass
- The technically permissible maximum mass of the towing
- The technically permissible maximum mass on each axle listed in order from front to rear

Location of VIN plate

VIN plate (1) is located at front lower of right side B post.

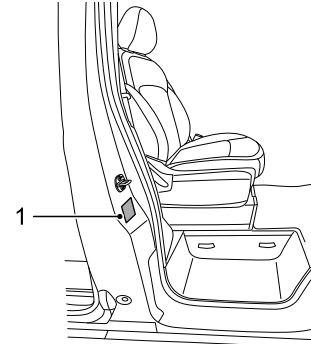

Before You Drive

- 8 Keys
 - 10 Door locks
 - 19 Windows
 - 22 Seats
 - 25 Passenger restraint system
 - 40 Instruments and controls
 - 41 Instrument cluster
 - 42 Message center
 - 46 Warning lights and indicators
 - 55 Exterior light switch
 - 57 Instrument cluster switch
 - 61 Master power switch
 - 62 Switches on steering column and steering wheel
 - 70 Steering wheel adjustment
 - 71 Heating, ventilation and air conditioning (HVAC)
 - 77 Rearview mirrors
 - 79 Interior equipment
 - 84 Electric step
 - 85 Entertainment system
-

Before You Drive

Keys

The vehicle is equipped 2 remote keys with passive entry passive start system (hereinafter referred to as PEPS).

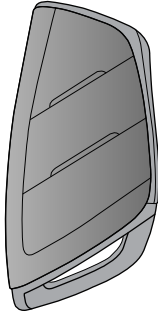

Note: *If a key is lost, you must provide the key number on the metal or plastic plate attached with the key, and the Our Service Dealer will provide the replacement. To ensure safety, you are recommended to keep the metal or plastic plate attached with key properly.*

Note: *For the sake of safety, the key has been electronically coded with the immobilizer system and can be used with the system in the matching way only. Special procedures shall be followed to manufacture a same key with the lost one. Any uncoded key cannot start the vehicle but can lock/unlock doors.*

Remote key with PEPS

The remote key is a control component of central door locking system of a vehicle, which can be used for locking/unlocking all doors.

Note: *The remote key has been electronically coded with the locking/unlocking system and can be used with the system in the matching way only. Special procedures shall be followed to manufacture a same remote key with the lost one. Our Service Dealer will be pleased to assist you.*

See "Central door locking system" in this section for more details about the remote key.

Caution

The immobilizer system can accept 4 coded keys at most (for remote keys with PEPS).

Extension/retraction of mechanical key portion of the remote key ("mechanical key portion" for short)

Press the release button on the remote key with PEPS, and pull the mechanical key portion from the key body.

To retract the mechanical key portion, directly insert it into the body of remote key with PEPS.

Before You Drive

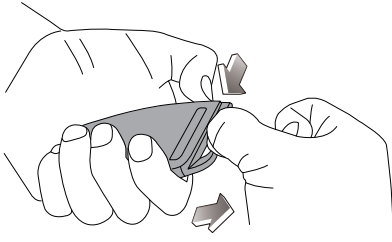

Replace the battery in the remote key with PEPS

! Batteries may present the risk of fire, explosion and burning. Never charge the battery. Properly dispose the used battery. Keep the battery out of reach of children.

! **WARNING:** Do not ingest the battery, chemical Burn Hazard.

This product contains coin/button cell battery. If the coin/button cell battery is swallowed, it can cause severe internal burns in just 2 hours and can lead to death. Keep new and used batteries away from children. If the battery compartment does not close securely, stop using the product and keep it away from children. If you think batteries might have been swallowed or placed inside any part of the body, seek immediate medical attention.

WARNING



To replace the battery, following procedures must be observed:

- 1 Press the release button on the remote key with PEPS.
- 2 Pull the mechanical key portion out of the key body.
- 3 Pry off the upper and lower panels of the body; the circuit board may fall off from the upper panel assembly when prying off them, and reinstall them.

Caution

Do not damage the circuit board when prying off the upper and lower panels.

- 4 Remove the used battery from the lower panel assembly and install a new one.

Note: It is recommended to use a CR2032 battery.

Caution

Pay attention to the positive and negative electrodes of battery.

Before You Drive

- 5 Refit the upper and lower panels of the battery body, and press their circumference to ensure they are clamped in place.

Caution

Do not ignore the waterproof shim and circuit board onto the upper panel of the key body.

- 6 Press the mechanical key portion into the key body.

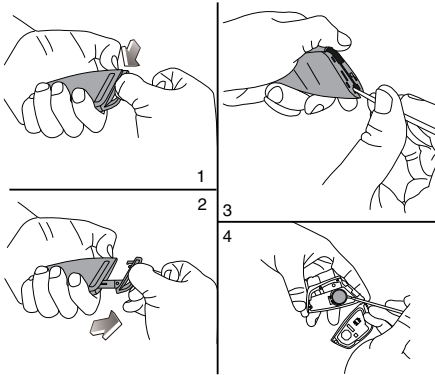

Caution

It is complicated to replace the battery in the remote key with PEPS. In order to prevent the key from being damaged due to misassembly or misoperation, you are recommended to have the battery replaced by Our Service Dealer.

Door locks

To protect your vehicle against theft

! When leaving the vehicle with occupants inside, even briefly, always carry the key and power off the vehicle, particularly if children are left in the vehicle. They could otherwise start the vehicle or operate electrical equipment at the risk of causing an accident.

Close all windows before leaving the vehicle.

Ensure all doors and hood are fully closed before locking.

Lock/unlock

You may lock/unlock all doors from outside by using the remote key with PEPS.

All doors can be locked/unlocked from the inside using central lock switch. All doors can be automatically locked according to the vehicle speed. See "Central door locking system" in this section.

Note: When all doors are successfully locked by using the remote key with PEPS, all turn signals will flash once, and the horn will sound once to indicate successful locking. When all doors are successfully unlocked with the remote key, all turn signals will flash twice to indicate successful unlocking.

Before You Drive

Central door locking system

Using the mechanical key portion

All doors can be locked/unlocked by manually locking/unlocking the driver door using the mechanical key portion from the outside.

To lock, turn the mechanical key portion clockwise.

To unlock, turn the mechanical key portion counterclockwise.

Using the remote key with PEPS

All doors can be locked/unlocked through the central door locking system using the buttons on the remote key with PEPS.

Note: All doors must be fully closed for the system to operate correctly.

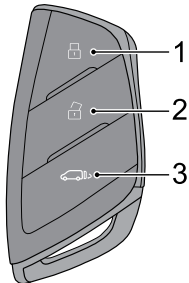

1 Central locking button (short press)/window up (long press)

Note: For the functions of window up (long press), please refer to your vehicle's actual configuration.

2 Central unlocking button (short press)/window down (long press)

Note: For the functions of window down (long press), please refer to your vehicle's actual configuration.

3 Tailgate unlocking button

Caution

When locking with the LOCK button  on the remote key with PEPS, if there is another legal remote key with PEPS in the vehicle, then the latter key will be disabled, and the passive entry and one touch start feature will be lost. To activate it: close all doors, operate the unlocking button on the remote key with PEPS in a normal manner, the key shielded inside the vehicle will be activated.

Caution

The key control strategies may be different depending on the vehicle configurations. Please operate subject to the actual configuration of your vehicle.

All doors locking

Short press the button  to lock all doors when the driver door is closed. All direction indicators will flash once and the horn will sound to indicate successful locking.

Before You Drive

Note: If all direction indicators flash once and the horn sounds, it indicates that locking has been confirmed; if any door is not fully closed, there will be no direction indicator flashing or audible warning. Press the button  only after all doors have been closed.

All doors unlocking

Short press the button  to unlock all doors. All direction indicators will flash twice to indicate successful unlocking.

Note: If no door is opened, no key is inserted into the keyhole, or no central locking/unlocking button is pressed within 30 seconds, all doors will be automatically locked again.

Tail door unlocking

Long press the button  to unlock the tail door. All direction indicators will flash twice to indicate successful unlocking.

Note: If no door is opened, no key is inserted into the keyhole, or no central locking/unlocking button is pressed within 30 seconds, the tail door will be automatically locked again.

Using the micro switch

Note: It applies to vehicles configured with keyless entry function.

PEPS system allows you to lock or unlock the doors without taking the remote key out of your pocket, wallet, or suitcase.

Unlock with the remote key with PEPS

As long as there is a legitimate remote key existing within the range of 1 meter around the vehicle, press the micro switch on the door handle, and the door will be unlocked.

Lock with the remote key with PEPS

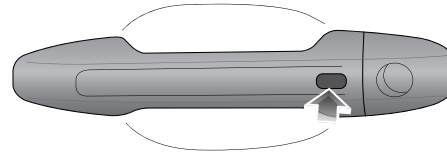

Turn off the ignition switch, leave the vehicle and close the door, then touch the micro switch on the door handle with your thumb, the door will be locked, and there is no need to press the locking button on the remote key.

Before You Drive

Using the central control door lock switch

All doors can be unlocked or locked from the inside using the switch. All doors can be locked by pressing the locking button .

All doors can be unlocked by pressing the unlocking button .

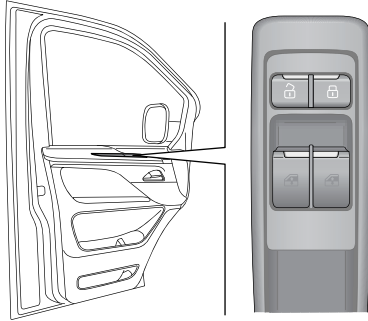

Note: If driver door is not closed, the lock motor will not operate. If any other door is not closed, the lock motor will operate.

The door can also be unlocked by pulling the inner handle twice.

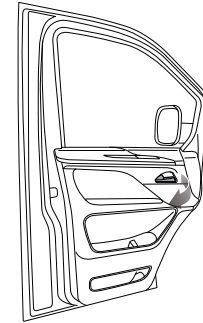

Note: During the driving, all doors shall be fully closed and all door locks shall be enabled, so as to avoid accidental opening of doors.

Locking according to the vehicle speed

When the vehicle speed exceeds 8 km/h, all doors can be locked automatically.

Note: When the ignition is turned off, the doors will automatically unlock.

Before You Drive

Emergency locking

When the battery is powered off/fed after the vehicle is unlocked, the vehicle cannot be locked by the key, the door emergency lock device can be operated with the key bit/appropriate tools.

Note: After the door is locked in emergency, please do not leave the key in the car. Otherwise, you will not be able to enter the car again.

Emergency locking of front door

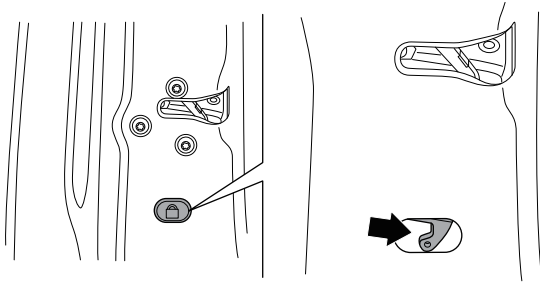

Emergency locking of side sliding door

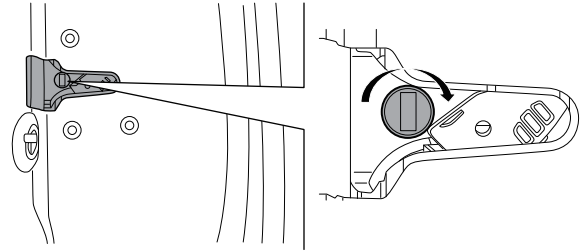

Emergency locking of tailgate

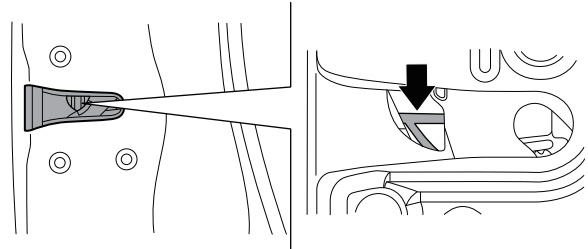

Before You Drive

Side load door(s)

Opening/closing the door from the outside

When opening the side load door from the outside, pull up the door outer handle to slide the side load door rearward after the vehicle is unlocked.

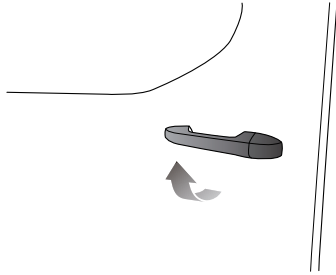

When closing the side load door from the outside, use the door outer handle to pull the side load door forward till it is closed.

Note: *The locking/unlocking of the side load door from the outside can be controlled using the remote key (See “Central door locking system” in this section).*

Opening/closing the door from the inside

When opening the side load door from the inside, pull up the door inner handle to slide the side load door rearward to open it after the vehicle is unlocked. When closing the side load door from the inside, pull up the door inner handle to slide the side load door forward till it is closed.

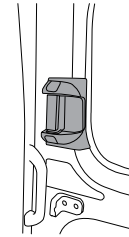

Fastening the door

Note: *When the side load door is fully opened, a “click” from the rear of lower rail indicates that the side load door is fastened.*

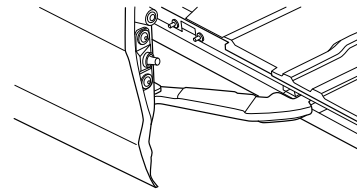

Before You Drive

Tail door

Unlocking/opening doors from the outside

When using the remote key or central control door lock switch to lock or unlock all doors, the tail door will also be locked or unlocked. After the tail door is unlocked, pulling up the outer handle of tail door can open the right hand tail door first.

To unlock manually or open the tail door from the outside, as for the vehicle with a keyhole, turn the mechanical key portion counterclockwise to unlock. If the vehicle doesn't have a keyhole, use the remote key to unlock it in an electronic form.

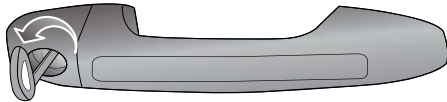

Then pull up the handle to open the right hand tail door first.

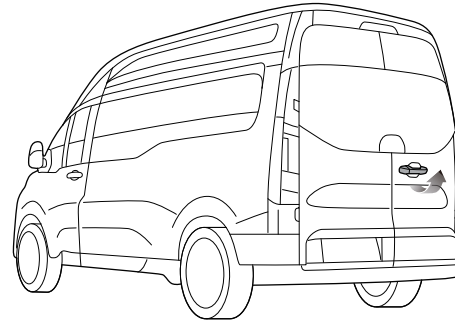

Pull the door handle at the side of the left hand tail door rearward to open the left hand tail door.

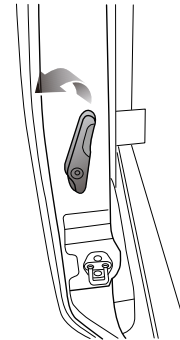

Before You Drive

Closing/locking doors from the outside

To close and lock the tail door from the outside, shut the left hand tail door first, and push the left hand tail door to close, then close the right hand tail door.

As for the vehicle with a keyhole, turn the mechanical key portion clockwise to lock. If the vehicle doesn't have a keyhole, use the remote key to lock in an electronic form.

Unlocking/opening doors from the inside

To unlock and open the tail door from the inside, pull the inner handle at the inside of the right hand tail door rearward to unlock the right hand tail door. Then pull the door handle at the side of the left hand tail door to open the left hand tail door.

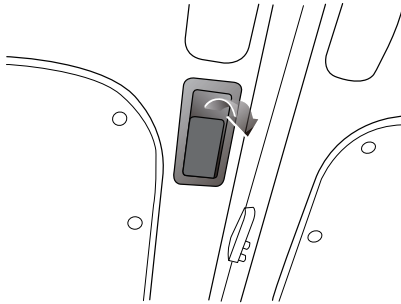

Opening/closing of tailgate 180°/255°

For the vehicles equipped with tailgate 180°, if any tailgate is opened by more than 90°, the tailgate opening angle will no longer be controlled by the limit device. For the vehicles equipped with tailgate 255°, the tailgate hinge has self-limiting function.

! The tailgate should not be opened to 180°/255° on the road, because this may obstruct traffic or cause injury to pedestrians.

When the tailgate is opened and there is a strong wind, the tailgate may swing, causing damage to passing pedestrians, other road users or vehicles.

In some cases, use of the tailgate may affect the warning effect of the rear combination lamp. When using the tailgate in the dark hours, it is recommended to use additional warning signs (such as highlighted reflective triangle warning signs or similar devices) to warn other vehicles or pedestrians.

When closing the tailgate, please close the left tailgate first, then close the right tailgate. Do not close the left and right tailgates at the same time to avoid damage to the car logo.

For the vehicles equipped with tailgate 180°, open the tailgate to 90° and then slightly pull the tailgate back to the closed position. The limit arm can be removed from the body side hook, then the

Before You Drive

tailgate can be opened to 180° freely. At this time, the limit arm can be fixed on the tailgate side bracket.

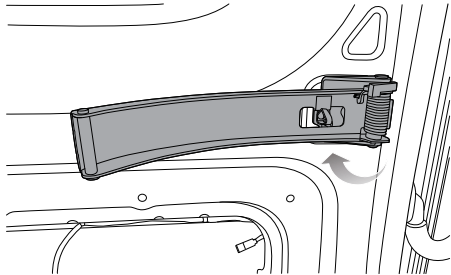
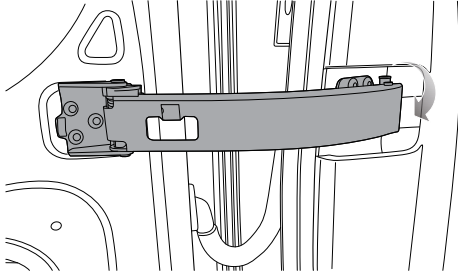

When the tailgate is closed from the position of 180°, the limit arm is removed from the tailgate side bracket, and will automatically return to the limit structure at 90°.

Child proof locks

Note: *It applies to vehicles configured with child proof locks.*

! When children are in the rear seats, use the child proof locks.

The child proof lock on the side sliding door is designed to prevent passengers, especially children, from accidentally pulling the interior door handle inside the vehicle and opening the side sliding door.

Caution

When the child proof lock is in the locked position, do not forcefully pull the interior door handle. This will damage the interior door handle.

To enable child proof locks:

- 1 Open the side sliding door you want to lock.
- 2 Locate the child proof lock on the side sliding door.
- 3 Push the child proof lock lever to the locked position.

Before You Drive

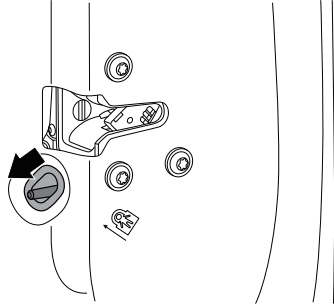

Caution

Each side sliding door has its own lock. The child proof lock on each side sliding door should be enabled and relieved manually, either on the left or right side.

After the child proof lock is enabled, the side sliding door can only be opened by operating the exterior door handle outside the vehicle. Push the child proof lock lever to the unlocked position to cancel the child proof lock.

Windows

Power window

! Always remove the key if leaving children unattended in the vehicle. Never allow children to operate the power window switch. Children who operate the switch might get stuck in the window, thereby causing serious injury. Be careful when closing the window. Careless operation may result in personal injury (such as bruise) or get clothing stuck.

Driver door window

There are 2 window switches on the driver door. The driver door window and the front passenger door window are operated respectively through the two switches. During operation, press the front of the switch to open the window. Lift the front of the switch to close the window.

Before You Drive

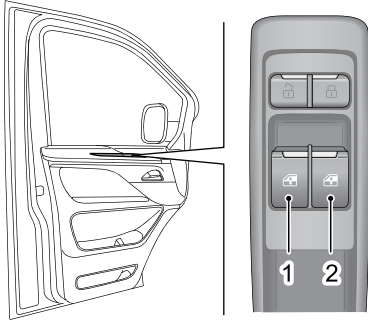

- 1 Driver door window control switch
- 2 Front passenger door window control switch

"One-touch" down (Automatic)

Note: It is applicable to models with automatic driver door window down function.

The switch button (1) has four positions, i.e., automatic down, single down, single up, and stop. It is convenient to control the window lifting process. The switch is in stop position normally. Short press the window switch down to the second down position, then the window will go down automatically.

The switch button (2) has three positions, i.e., single down, single up, and stop. It is convenient to control the window lifting process. During operation, press the front of the switch to open the window, and lift the front of the switch to close the window.

"One-touch" up and down (Automatic)

Note: It is applicable to models with automatic driver and front passenger door window lifting function.

The switch buttons (1) and (2) have five positions, i.e., automatic down, single down, automatic up, single up, and stop. It is convenient to control the window lifting process. The switch is in stop position normally. Short press the window switch down to the second down position, then the window will go down automatically; briefly lift the window switch up to the second up position, then the window will go up automatically.

- Leaving the car without worry

When the vehicle is turned off, press the lock button on the key to automatically close open windows on driver side and front passenger sides. Press the lock button again to pause the window.

Restoration of automatic lifting function

If the vehicle battery wiring is disconnected and then reconnected, or the battery power has been exhausted, or the window realizes anti-pinch function in the same position for successive three times when going up, the automatic lifting function may not work, and this function must be restored by relearning.

Close all doors and lift the window control switch until the windows are completely closed; after the windows are completely closed, continue to lift the switch for a few seconds.

Before You Drive

Press and hold the window control switch until the windows are completely opened; after the windows are completely opened, continue to press the switch for a few seconds and the automatic lifting function restores.

Front passenger door window

There is only one window switch on the front passenger door, including three positions, i.e., single down, single up, and stop. It is convenient to control the window lifting process. During operation, press the front of the switch to open the window, and lift the front of the switch to close the window.

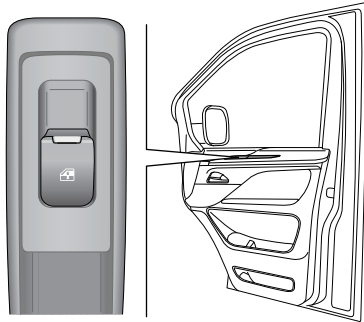

Note: The power window will work only when the ignition switch is in "ON" position.

Windshield heating

Note: It is applicable to models with windshield heating function.

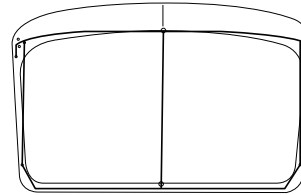

When encountering snow, rain or fog weather, the driver's vision is affected to a certain extent, resulting in great safety risks. The windshield temperature can be rapidly increased by turning on the windshield heating touch button on the entertainment system display, and the frost or fog attached to the windshield is melted by heat into water droplets or water vapor, so as to provide good driving conditions for the driver.

Caution

The windshield heating function will be turned off automatically after continuous operation for 10 minutes. When the cooling fan is started, it is not allowed to enable the windshield heating function. When the windshield heating function is enabled, if the vehicle recognizes the need for cooling fan, the windshield heating function will be turned off automatically.

Before You Drive

Seats

Driver and front occupant seat adjustment

Driver's seat adjustment

! Do not carry out driver's seat adjustment while the vehicle is moving. Otherwise control of the vehicle may be lost and cause an accident.

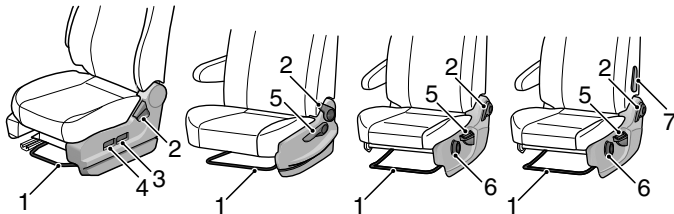

Fore and aft adjustment

Lift the bar (1) and slide the seat to the desired position. Release the bar (1) and check that the seat is locked in position.

Rake adjustment of backrest

! Do not recline the driver's seat excessively as the seat belt provides maximum protection when the angle between the backrest and the upright position is near 25°.

Slightly recline forward and pull up the adjuster (2); the seat backrest rebounds automatically. Then lean against the backrest to adjust it to the desired angle. Release the adjuster (2) and check that the seat back is locked in position.

Pad height adjustment

The front and rear of the seat pad can be adjusted independently for height. The height of the rear of the pad can be adjusted while holding up the lever (3), and the front while holding up the lever (4).

The seat pad can be adjusted for height. Pulling up the lever (5) can raise the pad, and pressing the lever (5) can lower the pad. To adjust the pad significantly, it is required to pull up or press down the lever (5) continuously.

The front of the seat pad can be adjusted independently for height by turning the knob (6).

Note: When increasing the pad height, ease your body weight from the seat pad; when decreasing the pad height, press the seat pad with your body weight to lower the pad height.

Lumbar support adjustment (if adjustable)

The lumbar support position can be adjusted by adjusting the lumbar support handle (7) to provide lumbar comfort support. The lumbar support handle (7) is adjustable within a range of 110°.

Before You Drive

Armrest height adjustment (if adjustable)

The armrest can be adjusted upwards from the lowest position as needed. There are three positions in total.

When it is required to lower the armrest from a higher position, it is necessary to raise the armrest to the highest position first, then lower the armrest to the lowest position, and then adjust the armrest upwards to the desired position.

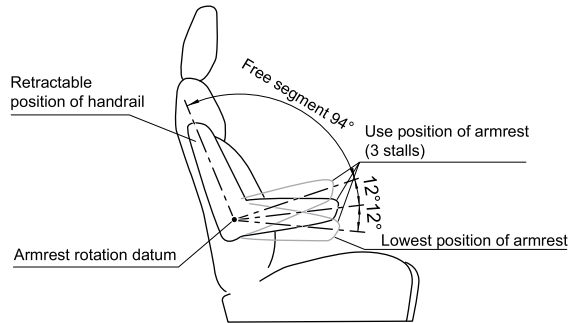

Front occupant single seat adjustment

Rake adjustment of backrest (if adjustable)

Rake adjustment of front occupant single seat backrest is the same as that of the driver's seat.

Armrest height adjustment (if adjustable)

Armrest height adjustment of front occupant single seat is the same as that of the driver's seat.

Front occupant dual seat adjustment

Rake adjustment of backrest (if adjustable)

- Split front occupant dual seat

Adjusting the outer handle (1) of the seat can adjust the rake of the outer seat backseat; rake adjustment is the same as that of the driver's seat. Adjusting the inner handle (2) can adjust the rake of the inner backrest; rake adjustment is the same as that of the driver's seat.

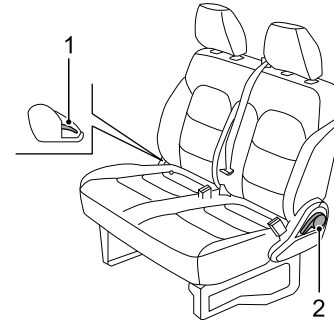

Before You Drive

- Integral front occupant dual seat

Adjusting the outer handle (1) of the seat can adjust the rake of the dual seat backseat. Rake adjustment is the same as that of the driver's seat.

- Fixed front occupant dual seat

The fixed front occupant dual seat backrest is not adjustable, without adjustment handle.

Pad lifting adjustment (if adjustable)

Note: It is applicable to the integral front occupant dual seat and the fixed front occupant dual seat.

Lift the front end of the pad to release the clip, and then lift the pad completely.

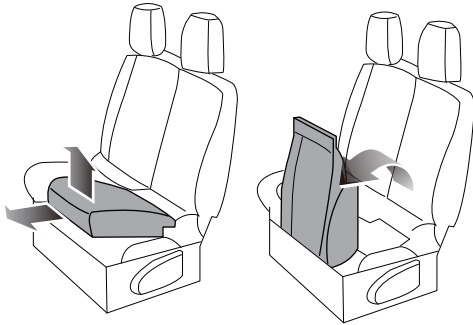

Seat armrest adjustment (if adjustable)

Note: It is applicable to the integral front occupant dual seat and the fixed front occupant dual seat.

The seat armrest is located in the middle of the inner seat backrest. Pull it down and push it flat forward for use. The cup holder is located at the rear of the armrest.

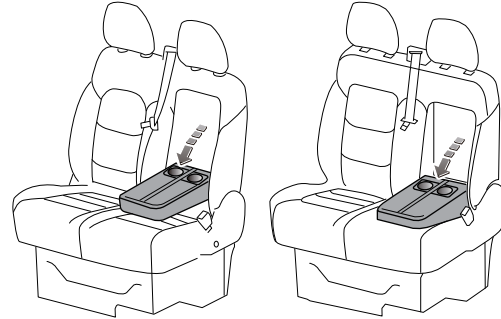

Integral front occupant dual seat

Fixed front occupant dual seat

Caution

Do not sit on the seat armrest or place heavy objects on it.

Headrest

! To reduce the risk of neck or head injury, the headrest should be adjusted to support the back of the head and not the neck. Do not adjust the headrest while the vehicle is in motion.

Press the arrowed button to push down or pull up the headrest to adjust the headrest to the desired position.

When pulling to a proper position, the headrest can be pulled out.

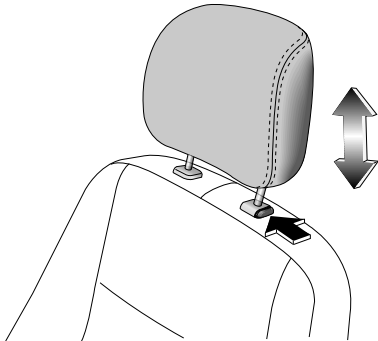

Passenger restraint system

Sitting correctly

The seat and its passenger restraint system have been designed to reduce personal injury to a minimum in the event of an accident. For optimum effectiveness, the following points should be observed.

- Do not position the seat nearer to the steering wheel than it is necessary.
- Do not over-recline the seat. Adjust the seat backrest to no more than 30° so that you can sit in an upright position with your arms slightly bent, and the base of your spine as far back as possible.
- Your headrest should be adjusted so that its center is level with the back of your head, not your neck.
- The shoulder belt should go through the center of your shoulder (adjust its height as necessary), while the lap strap fits tightly across the hips, not the stomach.



Before You Drive

Seat belts

 Improperly wearing or using seat belts may cause serious personal injury or death. Seat belts are life saving equipment. In a collision, unrestrained passengers may collide anywhere inside the vehicle or be possibly thrown out, resulting in injury to themselves or to other passengers.

When riding in a vehicle, the driver and any adult (or any adult sized child) must always fix the seat belt. **DO NOT** slacken the webbing by pulling the belt away from your body. To be fully effective, the webbing must remain tightly around your body at all times. Avoid wearing thick, bulky clothing. Put the shoulder belt of seat belt across the center of the shoulder and the lap belt close to the body to go over the hips. Strictly prohibit the use of slack and twisted seat belts, and seat belts can not be twisted to wear.

Never use a seat belt for more than one adult, and never use it to secure an additional object or a child. Each seat belt can only be used by one passenger. It's dangerous to wrap a seat belt around a child in the passenger arms.

When wearing a seat belt, ensure that it is not twisted or slack. Otherwise the smooth operation of the belt may be impeded. The buckle release button must face outwards.



Do not allow a baby or infant to be carried on the lap. The force of a crash can increase effective body weight, making it impossible to hold onto the child.

Do not allow foreign matters (particularly sugary food and drinks) to enter the seat belt buckle, such substances may render the buckle inoperative.

If the seat belt has been used in a serious accident, or shows serious wear, or has been cut, or the visual load meter shows that the seat belt is no longer available, or the seat belt is a pretensioner seat belt and after the pretensioner is triggered, the seat belt assembly must be replaced.

Pregnant women should ask their doctor for advice about the safest way to wear seat belts.

A seat belt must not be altered or modified in any way, since such changes may render the belt ineffective. Do not attempt to dismantle, repair or lubricate the retractor or buckle mechanisms.

Each seat belt is fitted with a retractor. When the seat belt is pulled out slowly, the retractor can ensure that the seat belt is retracted freely. But if the seat belt is pulled out too fast or under a sudden impact (a sudden deceleration, acceleration, sharp turn), the seat belt will be locked. See "Seat belts" in Maintenance and Service section for the specific inspection methods.

Before You Drive

! When the seat belt is not used, be sure to retract the seat belt webbing completely, straighten the webbing and put the tongue in place, and keep the webbing and tongue clean to prevent dust and impurities.

Be careful to avoid the erosion of webbing by polishing agents, oils and chemicals (especially battery acid). It can be cleaned safely with mild soap and water. After wear, erosion or damage of the webbing occurs, the seat belt assembly should be replaced.

The driver and front passenger seats of this series of models are equipped with adjustable pretensioner force-limiting seat belts.

! Insert the tongue into the buckle until a distinct click is heard, which indicates the belt is locked.

Caution

If the seat belt is pulled out too fast or the vehicle is located on the hill, the seat belt may be locked.

Seat belts

Type 1

During fastening, the seat belt is pulled out slowly, passes through the shoulder to be fastened in front of the body, verify that the belt is not twisted or tied, then push the tongue into the buckle until a click is heard.

During loosening, press the red button on the buckle, then the tongue will pop out under the action of the elastic force. Push the tongue back manually, so that the automatic seat belt retractor can contract the whole seat belt more easily.

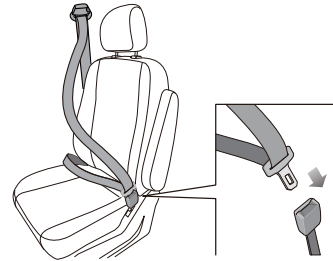

Type 2

During fastening, the seat belt is pulled out slowly, the fixed tongue is pushed into the buckle (1), and the movable tongue is passed through the abdomen and pushed into the buckle (2).

Before You Drive

During loosening, press the buttons on the buckles. Press the button on the buckle (2) first, then the button on the buckle (1).

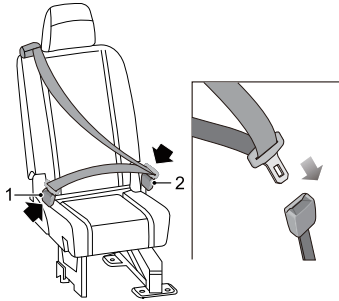

Seat belt with pretensioner (shoulder belt pretensioner)

In the event of serious collision accident, the pretensioner (integrated into the retractor) will be activated by the sensor, the shoulder belt (1) will be contracted a little immediately to prevent the occupants from moving forward and make them seated securely, so that it improves the function of the seat belt further.

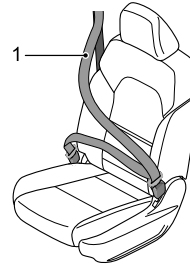

Seat belt warning light

See "Warning lights and indicators" in this section for the specific description of the "Seat belt warning light".

Before You Drive

Seat belt height adjustment

! Ensure that the slide adjuster is secure after making an adjustment.

Do not adjust the height of the driver seat belt while driving, as the control of vehicle may be lost.

Only the height of the driver seat and front passenger seat shoulder-to-hip belt can be adjusted.

Press the button (1) and slide the slide adjuster on the top of the belt up and down to suit the passenger height. Release the button (1) at the proper position.

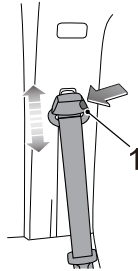

Seat belt pretensioner

! Do not damage or repair a pretensioner. It contains an ignition device, so that any maintenance can only be carried out by Our Service Dealer.

Pretensioners will not function after activation and must be replaced. In the event of a collision, ensure that the pretensioner and all seat belt components have been maintained by Our Service Dealer.

The seat belt pretensioner works together with the airbag to reduce the risk of injury in the event of a frontal collision.

1

Airbags



No safety system can provide complete protection for personal injury or death in a severe crash. Injuries or death can occur, even if seat belts are worn properly and the airbags inflate.

After inflation some airbag components are hot - DO NOT touch until they have cooled.

An airbag is inflated with considerable force and can cause facial abrasions and other injuries. These effects can be minimized by ensuring that you and your passenger(s) are wearing seat belts.

The driver seat should be adjusted to be as far rearwards as possible while maintaining the proper control of the vehicle.

Always hold the steering wheel by its rim, so that the airbag can be inflated without obstruction.

Never attach accessory items e.g. a mobile phone bracket, cup holder, cassette tray, etc. to the steering wheel cover or the airbag module cover, or stick/insert anything to an airbag module cover. Otherwise, these objects could interfere with inflation of the airbag. or after the airbag is inflated, they will be propelled into the vehicle to cause injury to passengers.

Do not allow a passenger to obstruct the deployment of the airbag by putting feet, knees, etc. in contact



with, or in close proximity to the airbag module cover.

It is forbidden to put the seat cover and other related decorative seat items that affect the deployment of seat airbags on the seats equipped with seat airbags.

Do not modify the seats equipped with seat airbags at will.

Do not paste any sharp objects on A, B, C and D pillars of the vehicle at will, and modify A, B, C and D pillars, so as to avoid injuries to passengers during the operation of airbags.

The seat belt pretensioner works together with the airbag to reduce the risk of injury in the event of a frontal collision.

Do not attempt to remove or pierce the steering wheel, or hit it violently.

Do not allow another person, animal or object to occupy the space between the driver and the deploying range of the airbag. The same applies on the passenger side if an airbag is fitted.

Do not attempt to maintain the steering wheel, steering column, any airbag system or pretensioner component, or the air bag components with wiring around. Otherwise, it could cause inadvertent activation of the system resulting in personal injury.

Before You Drive



Do not modify the front and both left and right sides of the vehicle in any way, as this could adversely affect the airbag deployment.

If the vehicle is to be scrapped, undeployed airbags are potentially dangerous and should be deployed before scrapping. This operation must be done by professional staff.

This vehicle can be equipped with the driver airbag, front passenger airbag, driver side airbag, front passenger side airbag and double side front-row curtain airbags.

Note: *Both the airbag and the pretensioner are supplementary protection device, while the seat belt is still the main protection device and must be worn during driving.*

Caution

- When an airbag is triggered, a loud noise may be heard and a small amount of smoke-like gas and dust will be released. This smoke does not constitute a health hazard. The dust may be an irritant to the skin and therefore should be washed off with soap and water.
- For safety reasons you are recommended to have the airbag(s) renewed by Our Service Dealer every 12 years. If the vehicle is sold, its owner is obliged to notify the purchaser of the cautions and warnings listed.

Airbag and pretensioner inspection



If the warning light does not come on after the ignition switch is turned on, or does not go off after about 6 seconds, or comes on during driving, it indicates that the seat belt pretensioner or airbag fails. Contact Our Service Dealer for service as soon as possible.

When the ignition switch is turned to "ON" position, if the "airbag



warning light (red)" on the instrument cluster will illuminate for about 6 seconds, it indicates that the airbag and seat belt pretensioner are being checked; if the "airbag warning light (red)" goes off after about 6 seconds, it indicates that the airbag and seat belt pretensioner are normal.

Before You Drive

Airbag deployment



Incorrect sitting posture, sitting on or leaning against the positions close to airbag may lead to severe or even fatal personal injury when the airbag is deployed.

To minimise the risk of accidental injury from inflating airbags, seat belts should be worn correctly at all times. The driver and front passenger must take correct sitting posture and adjust their seat to keep sufficient distance from front airbags, so as to avoid serious injury or death caused by deployed airbags. If side airbags and side front curtain airbags are fitted, both the driver and front passenger should be seated to maintain sufficient distance from the upper part of the body to the sides of the vehicle, so as to avoid injury caused by deployed airbags.

When airbags are deployed, children without proper protection may suffer from serious injury or even death. Do not carry children in the arms or on the knees during traveling. Children should wear seat belts suitable to age. It is forbidden to lean out of windows.

An inflating airbag may cause facial abrasions, physical injuries or burns caused by explosion.

The inflation passage of the airbag must be free of any obstructions. It is forbidden to place any objects

between passenger and airbag. It is forbidden to fix or place any objects on the steering wheel cover, or on/near the instrument panel front airbag cover. It is forbidden to affix any accessories or trims adjacent to the airbag system. If there is an obstacle between passenger and airbag, the airbag may not inflate properly, or the airbag will squeeze the obstacle into the passenger's body, causing serious injury or even death.

Do not knock or strike the position where airbags or related parts are located, so as to avoid accidental airbag deployment which may cause serious injury or even death.

When the airbag is deployed, some airbag components are hot, so do not contact it before cooling down.

In the event of a collision, the airbag control module monitors the speed change induced by the collision, to determine whether the airbags are deployed. Airbag deployment is virtually instantaneous and occurs with considerable force, accompanied by a loud noise.

The completely deployed airbag, together with the seat belt properly worn, can limit the movement of the driver and the front passenger, thereby reducing the risk of injury to the head and chest, in the event of the vehicle receiving a severe frontal collision.

Before You Drive

The completely deployed airbag, together with the seat belt properly worn, can limit the movement of the driver and the front passenger, thereby reducing the risk of injury to the head and chest, in the event of the vehicle receiving a severe frontal collision. If side airbags and side front curtain airbags are fitted, when the vehicle encounters serious side collision, completely deployed side airbags will form an air cushion between the occupant and the vehicle side to reduce the risk of body side injuries.

When you sit upright in the seat and against the backrest, seat belts and airbags can provide the most effective protection. When encountering serious collision, airbags will deploy drastically. At this moment, if you or other passengers do not use seat belts properly, and lean forward, recline or sit in other incorrect postures, you or other occupants are likely to suffer from serious injury or fatal injury.

Caution

- Airbags can not protect lower body parts of occupants.
- Airbags are not designed for rear collision, minor frontal collision, or vehicle overturning; they will not operate as a result of heavy braking.
- Deployment and retraction of the airbags takes place very quickly and will not protect against the effects of secondary collisions that may occur.
- After deployment, the airbags deflate immediately. This ensures that the driver's forward vision is not obscured.

- Schematic diagram for deployment area of driver and front passenger airbags

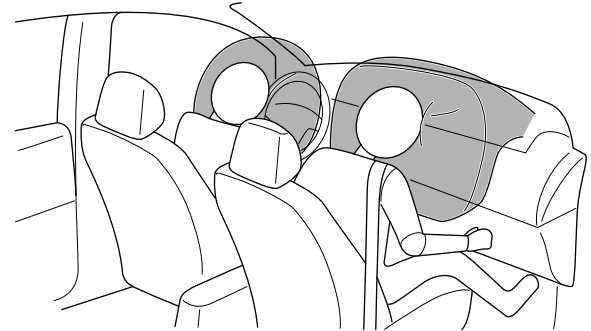

- Schematic diagram for deployment area of side airbags

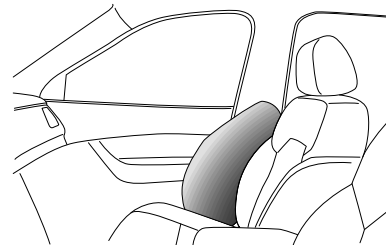

Before You Drive

- Schematic diagram for deployment area of front side curtain airbags

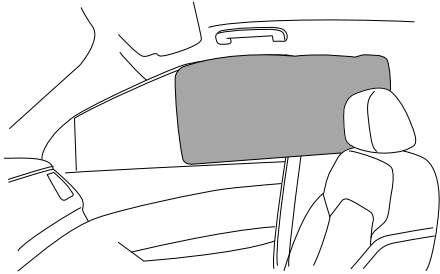

Front airbags

! NEVER fit the child restraint system in the front passenger seat. The deployment of the front airbag may cause serious injury or even death to children.

The driver and front passenger should not place feet, knees or any other part of the body in contact with, or in close proximity to a front airbag cover.

In extreme cases driving on very uneven surfaces may cause airbag deployment. Please take extra care when driving on uneven roads, so as to avoid injury due to accidental airbag deployment.

Front airbags are designed to deploy during serious frontal collisions or similar collisions. Conditions described below or similar ones may cause airbag deployment.

- A frontal collision with unmovable or non-deformable solid objects at a high speed.

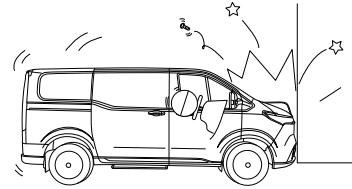

- Vehicle chassis are seriously damaged. The chassis may be damaged seriously when the vehicle collides with kerbstones, road edges, hard surfaces, or the vehicle falls into deep ravines or holes, or the vehicle hits the road seriously after jumping.

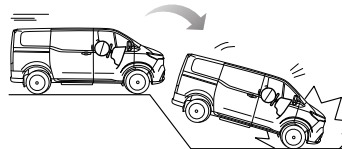
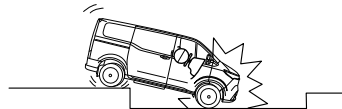

Before You Drive

Front side airbags

⚠ The structure and material of the seat is important to ensure correct operation of airbags. Therefore, please do not fit seat covers which may affect side airbag deployment.

In the event of a serious side collision, the front side airbag on the affected side will eject out from the seat cover and deploy quickly. The front side airbag on the other side will not deploy. Conditions described below or similar ones may cause side airbag deployment.

- One side of the vehicle collides with a high-speed ordinary passenger vehicle.

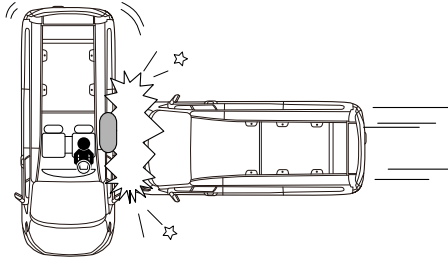

Front side curtain airbags

In the event of a serious side collision, the side curtain airbag on the affected side will eject out from the roof interior trim and deploy quickly. The side curtain airbag on the other side will not deploy. Conditions described below or similar ones may cause side curtain airbag deployment.

- One side of the vehicle collides with a high-speed ordinary passenger vehicle.

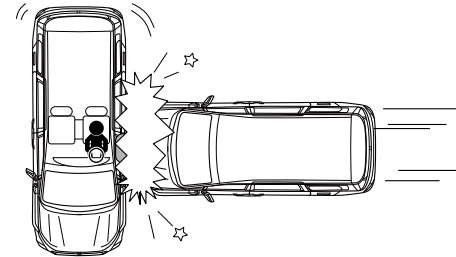

1

Before You Drive

Conditions in which airbags will not deploy

The deployment of airbags does not depend on the vehicle speed, but on the object that the vehicle hits, direction of collision and the rate at which the vehicle speed changes as a result of a collision. When the impact force of collision is absorbed or dispersed to the vehicle body, airbags may not deploy; however, airbags may sometimes deploy according to the impact condition. Therefore, the deployment of airbags shall not be judged based on the severity of vehicle damage.

Front airbags

Under conditions described below or similar ones, the front airbags may not be deployed.

- When the collision point deviates from the vehicle center.
- When the frontal collision is with solid utility poles, traffic sign posts, trees or other small area objects.

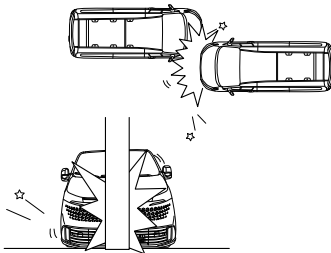

- Collision with the bottom part of the truck's tailgate; cut-in collision with trucks or vehicles with a higher chassis.
- Overlap frontal collision with guard bars.

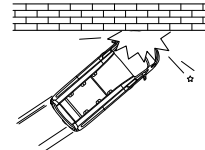
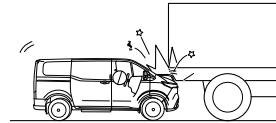

- Side or rear collision.
- The vehicle rolls over.

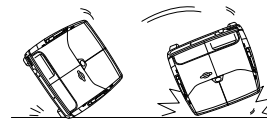
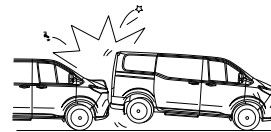

Before You Drive

Front side airbags and front side curtain airbags

Under conditions described below or similar ones, the front side airbags and front side curtain airbags may not be deployed.

- Side collision at certain angles.
- Side collision with a motorcycle.

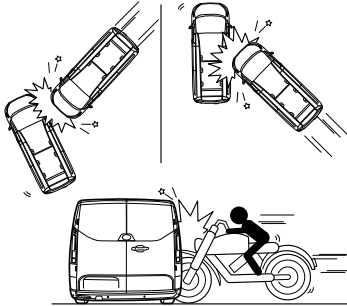

- Side collision to the front compartment of the vehicle.
- Side collision to the rear of the vehicle.
- The vehicle rolls over.

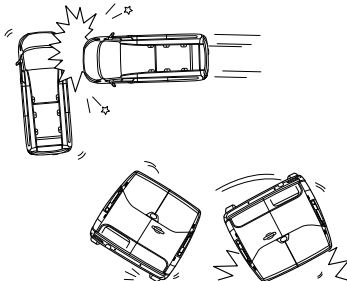

- Overlap frontal collision with guard bars.
- Side collision with posts.

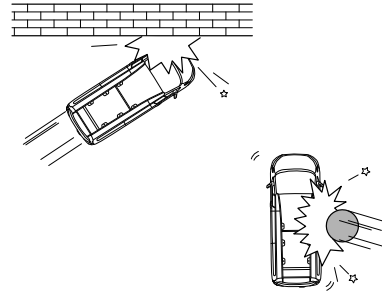

- Frontal collision with parking or moving vehicles.
- Rear collision.

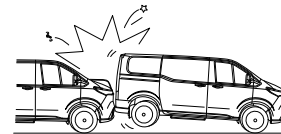
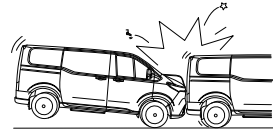

Before You Drive

Replace airbag system components after a collision accident



The airbag system will be damaged due to a collision accident. Thus the airbag system cannot operate normally to protect you and passengers in future collision accidents resulting in serious injury even death. To ensure the airbag system remains valid after a collision accident, consult Our Service Dealer to make inspection and necessary replacement of components.

Once the airbag is inflated, it is required to replace the components of the airbag system. Contact Our Service Dealer for service as soon as possible.

Event data recorder (EDR)

The vehicle is equipped with event data recorder (EDR). The main function of EDR is to record the data of vehicle movement and safety system status within a shorter time during collision or approach to collision. The EDR can be used to reproduce the vehicle state before, during and after the collision, such as speed, accelerator pedal opening and brake pedal depth. The EDR data extraction tool reads data based on an 11-bit CAN identifier, and reads EDR data by using 2216 "Read Data by Data Identifier" service in 11.2 of ISO 14229-1:2020, by physical addressing. Data can be read from the airbag controller through the special scan tool of the manufacturer. You can purchase the EDR data reader by logging in the link address of the company website.

Before You Drive

Child restraints (not supplied with the vehicle)

! **DEATH or SERIOUS INJURY may occur!** Children 12 and under can be killed by the airbag. **NEVER** use a child or infant restraint that faces backward on the front seat and the expanded airbag will cause serious child or infant injury and even death. Sit as far back as possible from the airbag.

NEVER use a rearward facing child restraint on a seat protected by an **ACTIVE AIRBAG** in front of it, **DEATH or SERIOUS INJURY** to the **CHILD** can occur!



Warning: Child restraint anchorages are designed to withstand only those loads imposed by correctly fitted child restraints. Under no circumstances are they to be used for adult seatbelts, harnesses, or for attaching other items or equipment to the vehicle.

When fitting and using a child restraint, always follow the manufacturer's instructions.

Usually, infants under 2 years old shall use a infant restraint and children under 2 ~ 4 years old shall use the child restraint. Infant or child restraints are available in the market.

Because there are various size and types of infant or children restraints, you are recommended to choose the suitable protection device depending on the infant's or children's age and weight to achieve the best protection. At the same time, you should check that the restraint is suitable for your vehicle as well.

Caution

In the case the infant or child restraint shall be positioned on the front seat while the vehicle is in motion, the infant or child restraint must face forward. Ensure properly secure the infant or child restraint. Note that an unsecured infant or child restraint may move and run into other occupants when any crash or heavy braking occurs. Even if there is no infant or child, any infant or child restraint shall be properly secured in the vehicle.

Before You Drive

Instruments and controls

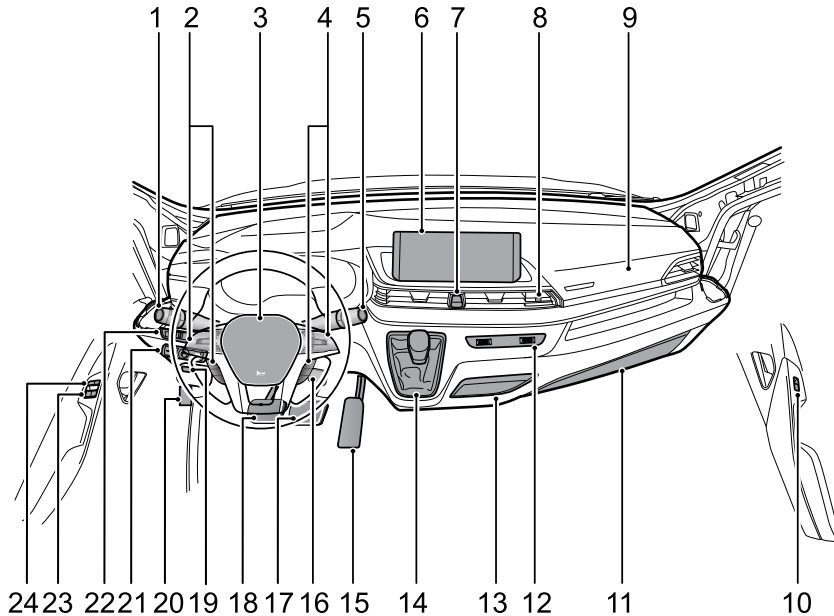

- 1 Combination lamp control and direction indicator stalk switch
- 2 Instrument cluster selection and cruise switch
- 3 Driver airbag
- 4 Voice control, Bluetooth phone, Steering wheel heating switch
- 5 Wiper and washer stalk switch
- 6 Entertainment system
- 7 Hazard warning light switch, Entertainment system HOME switch
- 8 USB port
- 9 Front occupant airbag
- 10 Front occupant door window control switch
- 11 Glove box
- 12 A/C control panel
- 13 Ashtray
- 14 Shift lever
- 15 Accelerator pedal
- 16 Ignition switch
- 17 Brake pedal
- 18 Clutch pedal
- 19 SOS alarm switch
- 20 Hood release switch
- 21 Exterior rearview mirror power adjustment switch, Headlamp leveling switch, Instrument cluster illumination control switch, USB port
- 22 EPB switch, AUTO HOLD switch, MODE (driving mode) switch, DPF switch
- 23 Driver and front occupant door window control switch
- 24 Central control door lock switch

Before You Drive

Instrument cluster

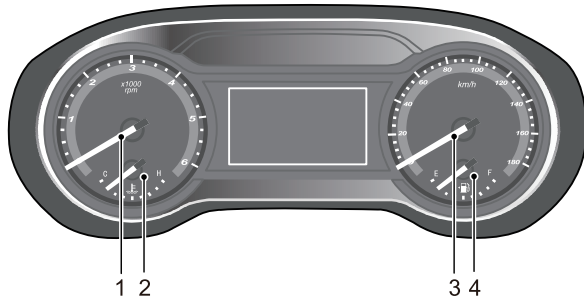

- 1 Tachometer
- 2 Engine coolant temperature gauge
- 3 Speedometer
- 4 Fuel gauge

Caution

Don't place any object in the front of the instrument cluster to avoid shielding dial and warning light.

Tachometer

The tachometer indicates the engine speed in revolutions per minute (x1000).

Caution

Never allow the pointer to remain in the red sector of the gauge for prolonged periods, otherwise the engine may be damaged.

1

Engine coolant temperature gauge

Indicates the approximate engine coolant temperature. If the coolant overheats, the "engine coolant temperature warning light (red)" will illuminate.

Caution

If the red warning light illuminates, stop the engine as soon as possible to cool the coolant. Check the engine cooling system.

Caution

For vehicles with low coolant level warning function, when the coolant level is too low, the red warning lamp will come on, accompanied with an audible alarm. Please stop the vehicle as soon as possible when the safety permits, turn off the engine and contact Service Dealer to check the engine cooling system.

Speedometer

The speedometer indicates the current road speed in kilometers per hour.

Before You Drive

Fuel gauge

Indicates the approximate amount of fuel in the tank. If the "low fuel level warning light (yellow)" stays on or illuminates, please refuel as soon as possible.

Caution

Be sure to refuel before the pointer points to the red "E" mark.

Message center

The message center display is located in the center of the instrument cluster.

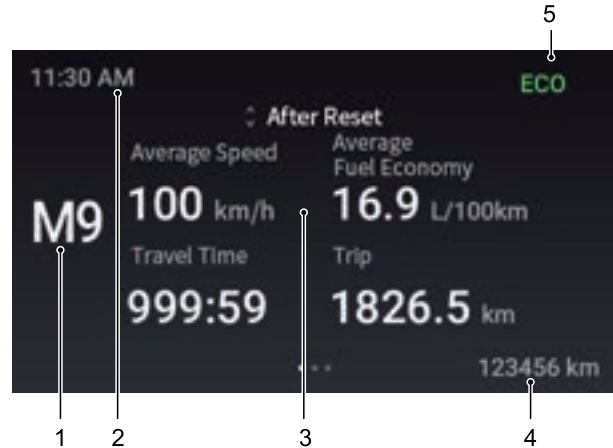

- 1 Gear display
- 2 Current time
- 3 Trip computer interface
- 4 Total mileage
- 5 Driving mode

Display the driving mode of the current vehicle. The instrument cluster message center displays ECO (economical mode) and POWER (sport mode). The driving

mode can be switched through the MODE switch on the console.

Short press the ◀ or ▶ button on the instrument cluster selection



switch on the steering wheel to switch the following interface contents: ADAS (Advanced Driver Assistance System) interface (if equipped) → trip computer interface → fault inquiry interface (in case of failure).

Note: *If the vehicle is not equipped with the relevant function, the interface will not be displayed.*

ADAS (Advanced Driver Assistance System) interface (if equipped)

It displays the relevant information of driver assistance system configured on your vehicle.

- LDW (Lane Departure Warning) prompt
- SLIF (Speed Limit Information Function) prompt

Trip computer interface

Short press the ▲ or ▼ button on the instrument cluster



selection switch on the steering wheel to switch between the following interface contents:

- Mileage

Driving mileage: it displays the estimated range that the vehicle can travel before the fuel tank is empty. After

refueling, the mileage will be updated accordingly. When the fuel level is too low, it indicates insufficient fuel.

Remaining maintenance mileage: this message reminds you of the remaining mileage of your vehicle before the next maintenance.

- Tire pressure monitoring (if available on your vehicle)

In normal mode, it displays the current tire pressure in real time.

- Instantaneous fuel consumption

It displays the instantaneous fuel consumption when the vehicle engine is working.

- After self-activated

It displays the trip, average speed, driving time and average fuel consumption since the vehicle is powered on to start.

- After self-reset

It displays the trip, average speed, driving time and average fuel consumption since the last reset.

In this interface, long press OK button on the steering wheel to reset the trip, average speed, driving time and average fuel consumption.

- Energy recovery

It displays energy recovery information.

- Urea level

It displays the percentage of remaining urea in the current vehicle.

Before You Drive

Fault inquiry interface

Short press the ▲ or ▼ button on the instrument cluster

selection switch  on the steering wheel to inquire the relevant fault messages for vehicle warning in this interface (if there is no fault, the interface will not be displayed).

Alarm messages

Most of alarm messages will have a corresponding graphic and text description in the instrument cluster. If more than one alarm message is activated, the new alarm message will be first displayed for 9 seconds, then the alarm messages will be displayed in a cycle; each alarm message will be displayed for 3 seconds. Some alarm messages, such as urea function alarm and DPF alarm, will be displayed in a cycle. Only when the alarm is canceled will the cycled alarm disappear.

Please operate in strict accordance with the instructions in the alarm message. If there is no relevant instructions, please stop the vehicle for inspection or consult our Service Dealer.

Important alarm messages

The currently displayed important alarm message can be temporarily canceled by short pressing the OK button on the steering wheel. It can also be viewed in the alarm query interface after canceled.

Caution

For the user's safety, when the door is open or the vehicle is in driving status, the alarm message cannot be canceled by short pressing the OK button on the steering wheel. The user must close the door and enter the trip computer interface to perform relevant operations when the vehicle is stationary.

If all the alarm messages are canceled, the trip computer information will be displayed normally. When the conditions

Before You Drive

of alarm activation are canceled, the corresponding alarm messages are also canceled to display.

Indicative messages

Indicative messages disappear automatically after 3 seconds.

Caution

Don't neglect the alarm messages, otherwise it may cause serious damage to the vehicle. If the warning light is on, please stop the vehicle as soon as possible if it is safe to do so.

Service interface reminders

Next maintenance reminder

When the message center of instrument cluster displays “XXkm remained before the next maintenance”, it reminds you of the remaining mileage of your vehicle before the next maintenance.

Imminent maintenance reminder

When the message center of instrument cluster displays “Maintenance period is imminent, please make maintenance as soon as possible”, it reminds you to go to our authorized service provider for maintenance as soon as possible.

Service now reminder

When the message center of instrument cluster displays “Please make service now”, it reminds you that the vehicle needs service now and you should go to our authorized service provider for maintenance as soon as possible.

Maintenance overdue reminder

When the message center of instrument cluster displays “Maintenance is overdue, please make immediate maintenance”, it reminds you that the vehicle maintenance is overdue and you should go to our authorized service provider for maintenance immediately.

Before You Drive

Tire pressure monitoring system

The tire pressure monitoring system automatically monitors the tire conditions in real time, providing effective safety guarantee for driving.

When the tire pressure is insufficient, too high, or the tire leaks quickly or the system fails in the course of driving, the "TMPS

warning light (yellow)"  on the instrument cluster illuminates, and the instrument display shows the corresponding alarm interface.

Warning lights and indicators

Direction indicator



The left or right "direction indicators (green)" flash when making a turn. When the hazard light switch is pressed, the left and right direction indicators flash simultaneously.

Note: If a direction indicator flashes rapidly, it indicates that the bulb in this direction indicator is faulty.

Headlight main beam indicator



The "headlight main beam indicator (blue)" illuminates when the headlights are on main beam or flash on.

IHC (Intelligent High Beam Control) indicator

Note: It applies to vehicles configured with IHC.



When the ignition switch is turned to ON position, if IHC system controls the high beam to illuminate, "IHC indicator (blue)" illuminates; when IHC system controls the high beam to go out, "IHC indicator (grey)" illuminates. See "IHC (Intelligent High Beam Control)" in the Starting and Driving section for more information.

Front fog light indicator



The "front fog light indicator (green)" illuminates when the front fog lights are on.

Rear fog light indicator



The "rear fog light indicator (yellow)" illuminates when the rear fog lights are on.

Position light indicator



The "position light indicator (green)" illuminates when the position lights are on.

Engine immobilizer warning light



With the ignition switch in ON position, if the engine immobilizer authentication is successful, the "engine immobilizer warning light (yellow)" will go out and the engine can be started. If the warning light flashes, it indicates that the immobilizer breaks down and the engine cannot be started. Please contact our Service Dealer for service immediately.

TPMS warning light



When the ignition switch is turned to ON position, the "TPMS warning light (yellow)" illuminates and goes out after several seconds. When the tire pressure monitoring system breaks down, the "TPMS warning light (yellow)" illuminates. Please contact our Service Dealer for service as soon as possible.

Fuel filter water level warning light



If the "fuel filter water level warning light (yellow)" illuminates when driving, stop the vehicle as soon as possible and drain water from the fuel filter. See "Draining fuel filter" in Emergency Troubleshooting section.

Glow plug indicator



When the ignition switch is turned to ON position, the "glow plug indicator (yellow)" illuminates. If the "glow plug indicator (yellow)" goes out after the preset time has elapsed, the engine can be started.

Caution

If the indicator stays on after the engine is started, please contact our Service Dealer for service as soon as possible.

Before You Drive

Engine malfunction warning light



When the ignition switch is turned to ON position, the "engine malfunction warning light (yellow)" illuminates and goes out after several seconds.

If the warning light illuminates, it indicates that the engine-related parts are faulty, please contact our Service Dealer for service as soon as possible.

Emission MIL



When the ignition switch is turned to ON position, the "emission MIL (yellow)" illuminates and goes out after the engine is started.

Caution

If the emission MIL stays on or illuminates while driving, it indicates that the operating system related to the vehicle emission is faulty. Please contact our Service Dealer for service as soon as possible, meanwhile, avoid high engine speed or fast acceleration.

DPF (Diesel Particulate Filter) warning light



When the ignition switch is turned to ON position, the "DPF warning light (yellow)" illuminates and goes out after several seconds. If the DPF warning light stays on, it indicates

a DPF Level 1 alarm, which requires high-speed driving or safe triggering of regeneration in situ; if the DPF warning light flashes, it indicates a Level 2 alarm, which requires immediate triggering of regeneration in situ if it is safe to do so. See "Catalytic converter" in Starting and Driving section for details.

Oil pressure warning light



When the ignition switch is turned to ON position, the "oil pressure warning light (red)" illuminates and goes out after the engine is started.

If the warning light stays on when the engine is running or illuminates while driving, shut down the engine immediately, check the oil level and contact our Service Dealer for service as soon as possible. See "Engine oil" in Maintenance and Service section.

Caution

Do not restart the engine even if the oil level is normal. Please contact our Service Dealer for service as soon as possible.

Battery no-charge warning light



When the ignition switch is turned to ON position, the "battery no-charge warning light (red)" illuminates and goes out after the engine is started.

Before You Drive

Caution

If the light fails to go out after the engine is started or illuminates while driving, it indicates that the charging system breaks down. Please contact our Service Dealer for service as soon as possible.

Engine coolant temperature warning light



When the ignition switch is turned to ON position, the "engine coolant temperature warning light (red)" illuminates and goes out after several seconds, which will indicate the engine coolant temperature. If the coolant is overheated, the red warning light in the instrument cluster will illuminate. For vehicles with low coolant level warning function, when the coolant level is too low, the red warning lamp will come on, accompanied with an audible alarm.

Caution

If the red warning light illuminates, stop the engine as soon as possible to cool the coolant, and contact our Service Dealer for service as soon as possible.

Low fuel warning light



When the ignition switch is turned to ON position, the "low fuel warning light (yellow)" illuminates and goes out after

several seconds, which will indicate the approximate fuel amount in the fuel tank. If the yellow warning light stays on or illuminates, please refuel as soon as possible.

Urea warning light



When the ignition switch is turned to ON position, the "urea warning light (yellow)" illuminates and goes out after several seconds. When the urea warning light flashes slowly, the buzzer sounds three times, indicating that the urea level is low; please refill as soon as possible. When the urea warning light flashes quickly, the buzzer sounds three times, indicating that the urea tank is empty; please refill as soon as possible after the speed is restarted or the speed has been limited to 20 km/h. When the warning light stays on, the buzzer sounds three times, indicating that serious emission system failure occurs, and the vehicle power is about to be limited (or after parking); please contact our Service Dealer for service as soon as possible.

Airbag warning light



When the ignition switch is turned to ON position, the "airbag warning light (red)" illuminates and goes out after several seconds.

If the light fails to come on or flash, or fails to go out, or if it comes on or flashes while driving, it indicates that there is a malfunction

Before You Drive

in the system. Contact our Service Dealer for service as soon as possible.

For further information about the airbags, see "Airbag(s)" in this section.

Seat belt warning light



When the ignition switch is turned to ON position, the "seat belt warning light (red)" illuminates and goes out after several seconds. When the driver and front occupant seat belts are not properly fastened, the "seat belt warning light (red)" illuminates. When the speed is greater than 22 km/h and the driver and front occupant seat belts are not properly fastened, the instrument cluster activates a seat-belt-unfastened audible warning. and the "seat belt warning light (red)" flashes for about 90 seconds. When the seat belts are fastened, the "seat belt warning light (red)" goes out and the audible warning stops. When the vehicle is in reverse gear or the speed is less than 10 km/h, and the driver and front occupant seat belts are not properly fastened, the instrument cluster does not activate any audible warning, while the "seat belt warning light (red)" illuminates. When the seat belts are fastened, the "seat belt warning light (red)" goes out.

Note: *Opening the door will reset the time when the seat belt warning light flashes.*

Brake system warning light



With the ignition switch in ON position, if the parking brake is applied, the "brake system warning light (red)" illuminates, and goes out once the parking brake is released completely. If the light fails to go out after the parking brake is released or illuminates again while driving, it indicates that the brake system breaks down; please stop the vehicle immediately, and contact our Service Dealer for service as soon as possible.

ABS (Anti-lock Braking System) warning light



When the ignition switch is turned to ON position, the "ABS warning light (yellow)" illuminates and goes out after several seconds.

If the ABS warning light fails to go out or illuminates again while driving, it indicates that the ABS breaks down; please contact our Service Dealer for service as soon as possible.

Note: *The brake system can be used even if ABS is faulty (ABS failure). See "Brake system" in Starting and Driving section for important information about ABS.*

EBD (Electronic Brake Distribution) warning light



When the ignition switch is turned to ON position, if the "EBD (Electronic Brake Distribution) warning light (red)" illuminates while driving, it indicates that the brake system is faulty, please contact our Service Dealer for service as soon as possible.

ESP (Electronic Stability Program) indicator



When the ignition switch is turned to ON position, the "ESP indicator (yellow)" illuminates and goes out after several seconds.

The "ESP indicator (yellow)" flashes when the ESP operates normally while driving.

The "ESP indicator (yellow)" illuminates when the ESP breaks down.

Contact our Service Dealer for service as soon as possible. For further information about ESP, please see "Brake system" in Starting and Driving section.

ESP (Electronic Stability Program) OFF indicator



When the ignition switch is turned to ON position, the "ESP OFF indicator (yellow)" illuminates and goes out after several seconds.

The "ESP OFF indicator (yellow)" illuminates when the ESP function is turned off by pressing the ESP OFF switch.

EPB (Electronic Parking Brake) indicator



When the ignition switch is turned to ON position and the electronic parking brake enabled, when the parking brake is applied, the "EPB (Electronic Parking Brake) indicator (red)" will illuminate and immediately go out after the parking brake is fully released.

EPB (Electronic Parking Brake) malfunction indicator



When the ignition switch is turned to ON position, if the "EPB (Electronic Parking Brake) malfunction indicator (yellow)" illuminates, the brake system is faulty. Please immediately stop the vehicle safely, and contact our Service Dealer for service as soon as possible. See "Brake system" in Starting and Driving section for more information.

Before You Drive

AUTO HOLD indicator

Note: *This applies to vehicles with AUTO HOLD.*

AUTO
HOLD

When the ignition switch is turned to ON position and the Auto Hold function enabled, the "AUTO HOLD indicator (white)" will illuminate; when the Auto Hold is activated, the "AUTO HOLD indicator (green)" will illuminate.

When the ignition switch is turned to ON position and the Auto Hold enabled, when the Auto Hold function is faulty, the "AUTO HOLD indicator (yellow)" will illuminate. See "Brake system" in Starting and Driving section for more information.

EPS (Electric Power Steering) system MIL



When the ignition switch is turned to ON position, the "EPS system MIL (red)" illuminates, which indicates that the EPS system breaks down; please stop the vehicle immediately, and contact our Service Dealer for service as soon as possible. See "Power steering unit" in Starting and Driving section for more information.

Cruise control indicator

Note: *It applies to vehicles configured with CC.*



With the ignition switch in ON position, if the cruise system is on standby, the "cruise control indicator (white)" illuminates; if the cruise system is active, the "cruise control indicator (green)" illuminates. See "Cruise control system" in Starting and Driving section for more information.

FCW (Forward Collision Warning) warning light/AEB (Automatic Emergency Braking) warning light

Note: *It applies to vehicles configured with FCW and AEB.*



When the ignition switch is turned to ON position, if the FCW/AEB function is not enabled or is faulty, the "FCW/AEB warning light (yellow)" illuminates; if the FCW/AEB function is enabled, the warning light will not illuminate. If the FCW system gives an alarm, the "FCW/AEB warning light (yellow)" flashes; if the AEB function is triggered, the "FCW/AEB warning light (red)" flashes. See "FCW (Forward Collision Warning) and AEB (Automatic Emergency Braking)" in the Starting and Driving section for more description.

LDW (Lane Departure Warning)/LKA (Lane Keep Assist) /ELK (Emergency Lane Keeping) warning light

Note: *It applies to the vehicles with LDW, LKA and ELK.*



When the ignition switch is turned to the ON position, if LDW, LKA and ELK are operating, the “LDW warning light/LKA warning light /ELK warning light (white)” illuminates.

When LDW, LKA and ELK give an alarm or are triggered, the “LDW warning light/LKA warning light /ELK warning light (yellow)” flashes.

When LDW, LKA and ELK are disabled, the “LDW warning light/LKA warning light /ELK warning light (yellow)” illuminates.

If the warning light illuminates in yellow when LDW, LKA and ELK are enabled, it indicates that the LDW, LKA and ELK break down. Please contact our authorized service provider for service as soon as possible.

See “LDW (Lane Departure Warning)/LKA (Lane Keep Assist) /ELK (Emergency Lane Keeping)” in the Starting and Driving section for more description of their functions.

SLIF (Speed Limit Information Function) indicator

Note: *It applies to vehicles configured with SLIF system.*



When the ignition switch is turned to the ON position, if a traffic sign is detected, the “SLIF indicator” illuminates. See “SLIF (Speed Limit Information Function)” in the Starting and Driving section for more information.

Speed limit indicator

Note: *It applies to vehicles configured with speed limit indicator.*



When the ignition switch is turned to the ON position, if the vehicle speed limit function is enabled, the “speed limit indicator (yellow)” illuminates with sound alarm. When the vehicle speed limit function is disabled, the “speed limit indicator (yellow)” goes out and the sound alarm stops.

Normal (Normal mode) indicator



When the ignition switch is turned to ON position, the “Normal indicator (white)” illuminates and the vehicle will be driven in normal mode.

ECO (Economical mode) indicator



When the ignition switch is turned to ON position, when the vehicle switches to economical mode, the “ECO indicator (green)” illuminates and the vehicle will be driven in economy mode with relatively weak output power from the vehicle engine.

Before You Drive

POWER (Sport mode) indicator

POWER

When the ignition switch is turned to ON position, when the vehicle switches to sport mode, the "POWER indicator (red)" illuminates and the vehicle will be driven in sport mode with relatively strong output power from the vehicle engine.

Trailer indicator

Note: It applies to vehicles configured with trailer indicator.



When the ignition switch is turned to the ON position, if the trailer is connected successfully, when the turn signal lamp is turned on, "trailer indicator (green)" on the instrument cluster flashes. When the trailer connection fails, "trailer indicator (green)" on the instrument cluster goes off.

Auto stop/start system indicator

Note: It applies to vehicles configured with auto stop/start system.



When the ignition switch is turned to ON position, the start/stop system is enabled, while the conditions for start/stop are not met, the "auto stop/start system indicator

(white)"  illuminates.

With the ignition switch in ON position and the start/stop system enabled, if the engine shuts down automatically, the "auto

stop/start system indicator (green)"  illuminates.

With the ignition switch in ON position and the start/stop system enabled, if the start/stop system breaks down, the "auto

stop/start system indicator (yellow)"  illuminates.

See "Auto stop/start system" in Starting and Driving section for more information.

Electric step indicator

Note: It applies to vehicles configured with electric step.



If your vehicle is equipped with electric step, when the door installed with the electric step is opened, when the electric step is in the process of extending or retracting, the "electric step indicator (yellow)" flashes and the instrument cluster activates an audible warning. When the electric step is fully extended, the "electric step indicator (yellow)" illuminates. Closing the door with the electric step installed will extinguish the "electric step indicator (yellow)". When the electric step fails to fully extend or retract, the "electric step indicator (yellow)" flashes and the instrument cluster continuously activates an audible warning. Close all doors tight before driving.

Exterior light switch

Combination light control switch control switch Light control switch

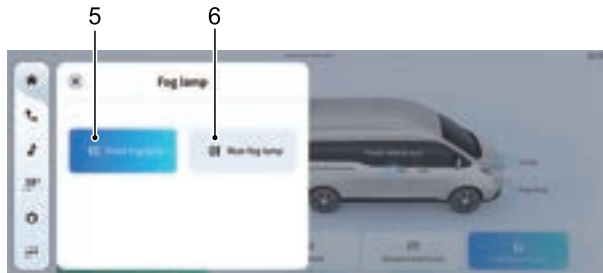
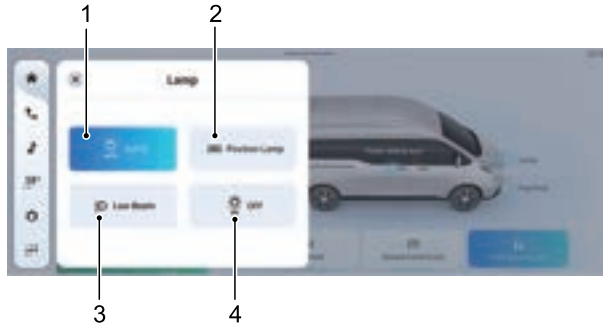



The light control switch is on the entertainment system screen. Please operate it through the touch keys on the entertainment system screen. Click the lamp touch button, and

the corresponding lamp will light up. The daytime running lights automatically illuminate after the vehicle is started.

1  AUTO: Headlamp control switch. When the headlamp



switch is in  AUTO position, the headlamps turn on or off according to the ambient lighting. The daytime running lights automatically illuminate when other lights are not lit after the vehicle is started.

2  Position Lamp: Position lamps switch. When the headlamp switch is in  Position Lamp position, the following lights illuminate:



- Position lamps
- License plate lamps
- Dashboard lights

3  Low Beam: Headlamps low beam switch.









Note: If headlamps are on when the vehicle is parked, the battery will discharge, and the vehicle may be unable to restart due to battery lack of power. An audible warning will sound if the headlamp switch is on when the vehicle is powered off.

Note: Before the vehicle is powered off, if the headlamp control switch is in  AUTO position, the headlamp control switch is still in  AUTO position after the vehicle is powered on again.

Before You Drive

Note: Before the vehicle is powered off, if the headlamp control switch is not in  AUTO position, the headlamp control switch is in  OFF position after the vehicle is powered on again.

Note: See "Switches on steering column and steering wheel" in this section for more operation methods of turn signals and headlamps.

- 4  OFF: Headlamp OFF switch. Click the Headlamp OFF switch to turn off the lamp.
- 5  Front fog lamp : Front fog lamp switch. When the ignition switch is in the "ON" position, press the  Front fog lamp switch to turn on the front fog lamp. When the front fog lamps are turned on, the "front fog light indicator (green)" on the instrument cluster illuminates. Press the  Front fog lamp switch again to turn off the front fog lamp.
- 6  Rear fog lamp: Rear fog lamp switch. With the ignition switch is in the "ON" position, when the low beam or the high beam or the front fog lamp is turned on, press the  Rear fog lamp switch to turn on the rear fog lamps. Press the  Rear fog lamp switch again to turn off the rear fog lamps. With other lights turned off, press the  Rear fog lamp switch, the rear fog lamps will illuminate along with the low beam. Press the  Rear fog lamp switch again, the

rear fog lamps will go out along with the low beam. When the rear fog lamps are turned on, the "rear fog light indicator (yellow)" on the instrument cluster illuminates.

Note: Rear fog lamps shall not be used until the visibility is obviously restricted (such as heavy fog or snow).

Daytime running lamp

Daytime running lamps make it easier for others to see the front of your vehicle clearly during the day.

If your vehicle is equipped with daytime running lamps, the daytime running lamps will illuminate when the vehicle is powered on. The low beam, taillights, position lamps, and other lamps do not illuminate when the daytime running lamps are on. When the vehicle is powered off, the daytime running lamps will go out. Comply with ECE R87 regulatory requirements for daytime running lamps.

Before You Drive

Instrument cluster switch

Headlamp leveling switch

The headlamp leveling switch is located on the instrument cluster at driver side.

With this function, the headlamp leveling can be adjusted to the condition suitable for the vehicle driving roads. The correction of headlamp leveling can reduce the dazzling light to other drivers.

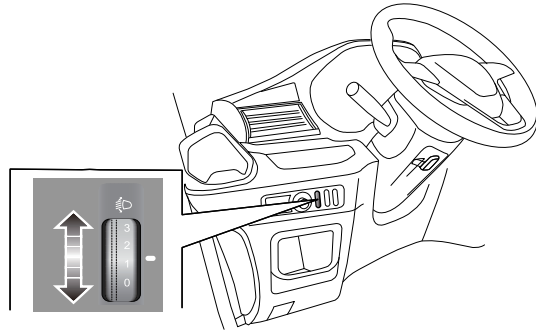



Move the headlamp leveling switch  upwards or downwards to adjust the headlamp leveling. 0 position is the original position. As the vehicle loads increase, adjust the illuminating height according to the sequence of 1-2-3.

Instrument cluster illumination control switch

The instrument cluster illumination control switch is located on the instrument cluster at driver side.

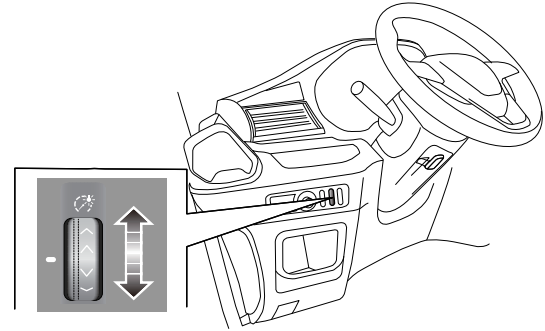
1



Use the instrument cluster illumination control switch  to adjust the brightness of instrument cluster illumination.

Move the switch  upwards or downwards to brighten or dim the illumination lamp.

Before You Drive

EPB (Electronic Parking Brake) switch

When the vehicle is stationary and the EPB switch (ⓐ) is pulled up, the indicator lamp in the switch illuminates and the parking brake is applied. When the "EPB (Electronic Parking Brake) indicator (Red)" on the instrument pack illuminates, the parking brake is applied successfully.

When depressing the brake pedal and pressing the EPB switch (ⓐ), the indicator lamp in the switch will go out and the parking brake will be released. When the "EPB (Electronic Parking Brake) indicator (Red)" on the instrument pack goes out, the parking brake is released. See "Brake system" in Starting and Driving section for more information.

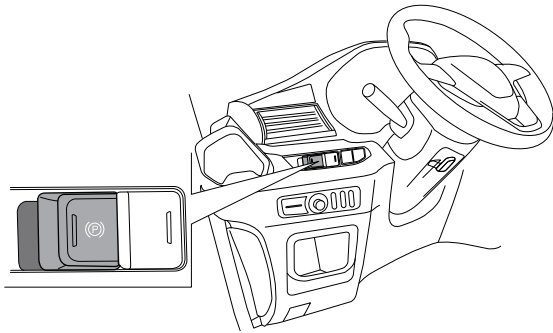

AUTO HOLD switch

Note: It is applicable to the vehicle equipped with AUTO HOLD function.

When pressing the AUTO HOLD switch (ⓐ), the indicator lamp in the switch will illuminate, and the "AUTO HOLD indicator (white)" on the instrument pack will illuminate. When the vehicle is stationary and the "AUTO HOLD indicator (green)" on the instrument pack illuminates, the auto hold is operating and the driver can release the brake pedal.

Note: The following conditions should be met to turn on the auto hold function: the driver door is closed; the driver seat belt is fastened; the vehicle is started.

When pressing the AUTO HOLD switch (ⓐ), the indicator lamp in the switch will go out, the "AUTO HOLD indicator (white)" on the instrument pack will go out, and the auto hold function will be off. See "Brake system" in Starting and Driving section for more information.

Before You Drive

1

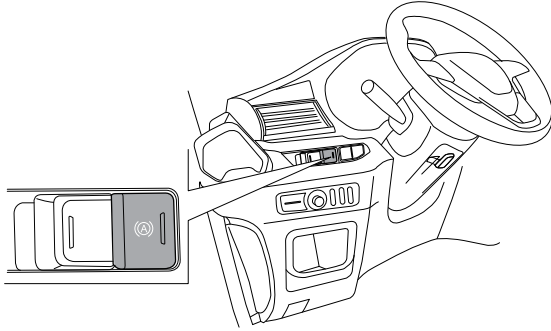

MODE (driving mode) switch

The MODE (driving mode) switch is divided into three modes: Normal, ECO, and POWER. The default mode is Normal. Press the MODE switch in sequence, and the driving mode switch sequence is: POWER (sport mode) → ECO (economy mode) → Normal (normal mode). Repeat this cycle, and at the same time, the instrument cluster will display: POWER indicator (red) → ECO indicator (green) → Normal indicator (white) to light up and display. In ECO mode, the output power of the vehicle engine is relatively weak. In POWER mode, the vehicle engine outputs relatively strong power.

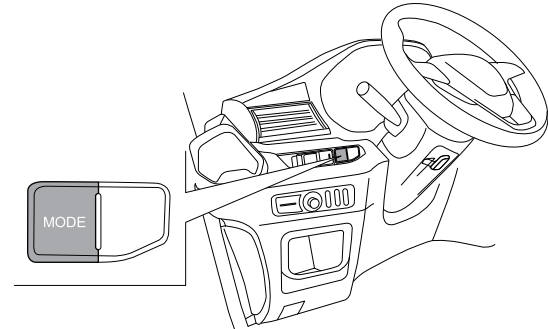

Before You Drive

DPF one-touch regeneration switch

When the "DPF warning light (yellow)" on the instrument cluster



is always ON or flashes, park the vehicle in an open and ventilated area to make sure there is no any flammable material (such as dry grass, oils, etc.) around. Stop the vehicle, with the manual transmission model in neutral gear (AT automatic transmission model in P gear), enable the parking brake, and turn off the ignition switch for two minutes; start the vehicle, and press down the on-touch regeneration switch  for 2 seconds, then release it, so the regeneration starts. See "Catalytic converter" in Starting and Driving section for details.

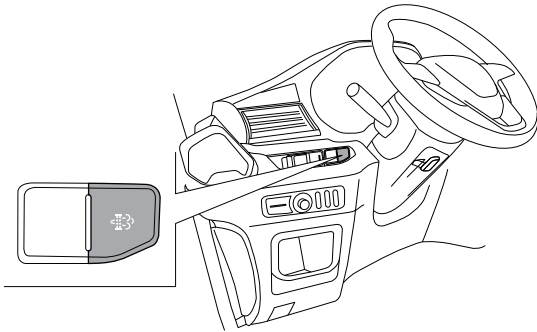

SOS alarm switch

Note: It is applicable to the vehicle equipped with the SOS alarm switch.

In case of an emergency, you may press the SOS alarm switch to send signals to the monitoring platform, and the platform can carry out the subsequent assistance work.

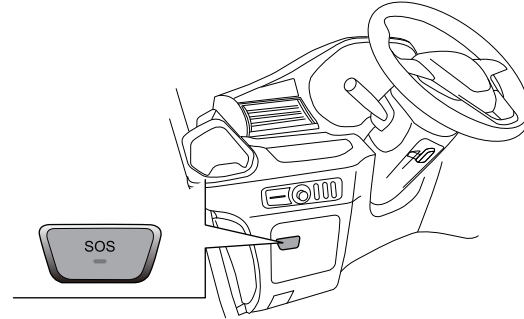



Caution

This switch is for emergency use only, please do not operate it without permission.

Before You Drive

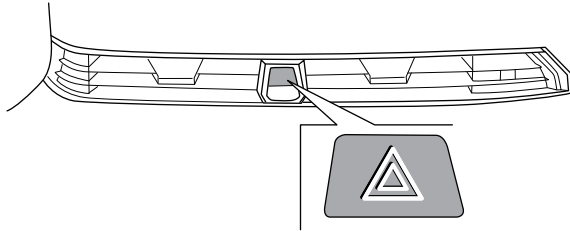
Hazard warning light switch



Press the hazard warning light switch  to activate all the direction indicators simultaneously, and the "direction indicator (green)" in the instrument cluster will illuminate and flash. Press the switch again to turn off the above lights.

Note: Turn on hazard warning lights to prompt other vehicles that your vehicle has a malfunction and approaching your vehicle may be dangerous.

Note: The switch type mentioned above may not applicable to your vehicle, which shall be subject to the actual configuration of the vehicle you purchased.

Master power switch

The master power switch is a mechanical power cut-off switch which disconnects the battery from all circuits. Before driving, open the door, move the driver seat forward, and turn the master power switch clockwise from the position vertical to the bracket (off state) to the position parallel to the bracket (on state). At this time, the master power supply of the vehicle is turned on.

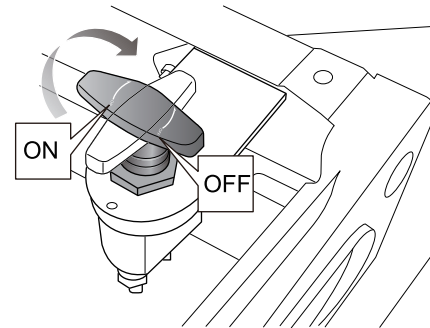

Caution

The function of master switch is, if the vehicle is not used for a long time, disconnect the master switch to prevent the battery feed; Disconnect the master switch is not recommended when the engine is started.

Before You Drive

Switches on steering column and steering wheel

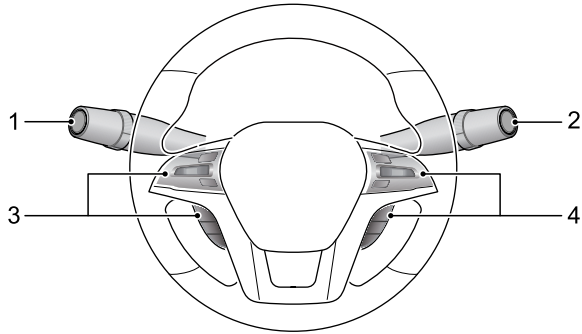

- 1 Combination lamp control and direction indicator stalk switch
- 2 Wiper and washer stalk switch
- 3 Instrument cluster selection and cruise switch
- 4 Voice control, Bluetooth phone, steering wheel heating switch

Combination light control & direction indicator light stalk switch

Light control switch

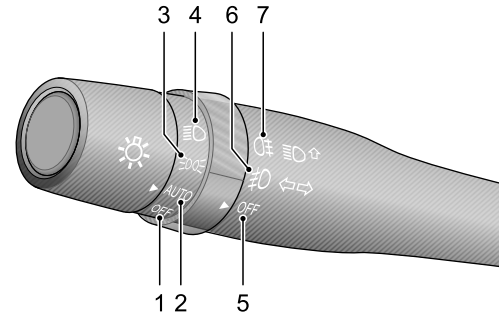

Rotate the light control switch to the positions shown, and the corresponding light illuminates.

Before You Drive

Position 1 - OFF: headlights off. Daytime running lights automatically illuminate after the vehicle is started.

Position 2 - AUTO: headlights automatically adjust. When the headlight switch is rotated to position 2, the headlights turn on or off according to the ambient lighting. The daytime running lights automatically illuminate when other lights are not lit after the vehicle is started.



Position 3 - : position lights on. When turning on the position lights, the following lights illuminate:



- Position lights
- License plate lights
- Dashboard lights

Position 4 - : headlights low beam on.

Note: Headlights will only operate when the ignition switch is in position "ON". If headlights are on when the vehicle is parked, the battery will discharge and the engine may be unable to restart due to battery lack of power.

Position 5 - OFF: fog lights off.

Position 6 - : front fog lights on. When the ignition switch is in position "ON", rotating the switch to  position turns the front fog lights on. When the front fog lights are turned on, the "front fog light indicator (green)" on the instrument cluster illuminates.

Position 7 - : rear fog lights on. When the ignition switch is in position "ON" and the light control switch is in high beam or low beam or front fog lamp (if equipped with front fog lamp) on position, rotating the switch to  position turns the rear fog lights

on. When the light control switch is in position "AUTO" and the switch is rotated to  position, the rear fog lights illuminate or go out along with the headlights according to ambient lighting. When the rear fog lights are turned on, the "rear fog light indicator (yellow)" on the instrument cluster illuminates.

Note: Rear fog lights shall not be used until the visibility is obviously restricted (such as heavy fog or snow).

Before You Drive

Direction lights and indicators

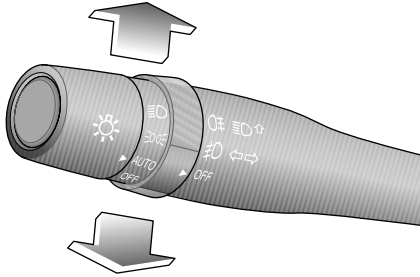

Right turn — push the lever switch upward.

Left turn — pull the lever switch downward.

The appropriate "direction indicators (green)" in the instrument cluster illuminate in time with the indicator lights.

Headlight high and low beams

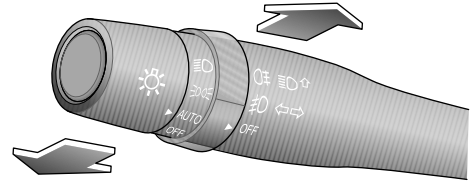

Push the lever switch away from the steering wheel to change the headlights from low to high beam. Pull the lever switch towards the steering wheel to return to the low beam position.

Note: The "headlight main beam indicator (blue)" in the instrument cluster illuminates when the headlights are on main beam. To flash the headlights, slightly lift the lever switch intermittently towards the steering wheel.

Before You Drive

Daytime running light

Daytime running lights make it easier for others to see the front of your vehicle clearly during the day.

If your vehicle is equipped with daytime running lights, the daytime running lights will illuminate when the ignition switch is in position "ON". The low beam, taillights, position lights, and other lights do not illuminate when the daytime running lights are on. When the ignition switch is in position "OFF", the daytime running lights go out.

Comply with ECE R87 regulatory requirements for daytime running lights.

Wiper and washer lever switch

Windshield wiper and washer

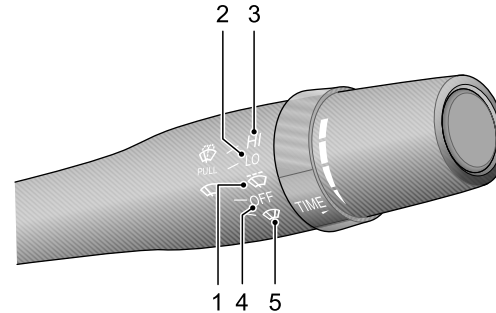

Rotate the lever switch to the desired position.

Before You Drive

Position 1 - : intermittent wipe. For vehicles equipped with automatic wipers, the rain sensor detects the rainfall on the windshield and automatically adjusts the wiping frequency of windshield wipers.

Note: *Always keep the rain sensor free of dust, dirt or ice.*

Position 2 - LO: low-speed wipe.

Position 3 - HI: high-speed wipe.

Position 4 - OFF: wiper off.

Position 5 - : single wipe.

Intermittent wipe/variable delay

 **Worn wiper blades may not clear the windshield properly, thus reducing forward visibility and be the cause of an accident. Always renew worn wiper blades immediately.**

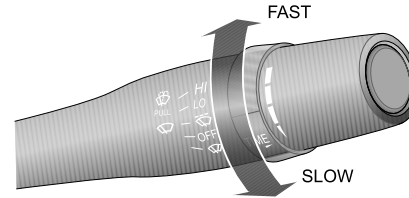

When the lever switch is in  (intermittent) position, rotate the switch to vary the delay between wipes.

Caution

In freezing or very hot conditions, to prevent damage to the wipers, ensure the blades are not frozen or otherwise adhering to the glass, and clear the screen of obstructions such as snow. Do not operate wipers when the windshield is dry. It can scratch the glass, cause the blades to wear prematurely and obscure vision.

Before You Drive

Washers

Pull the lever switch towards the steering wheel. The washer will operate immediately. After a short interval, the wiper will operate with the washer. The washer will be off when the lever switch is released.

Note: The wipers will continue to operate for 3 wipes after the lever switch is released.

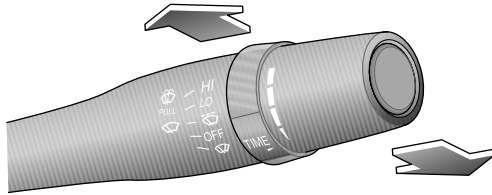

Instrument cluster selection and cruise switch

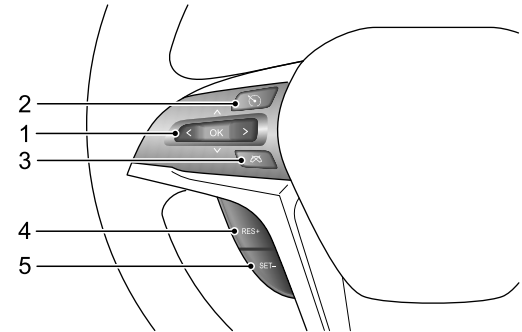

1

Position 1 -  : Instrument cluster selection button. Press upward, downward, leftward or rightward to page up, page down, page left or page right on the instrument cluster; press OK button to confirm your selection.

Cruise control system

Position 2 -  : Cruise on/off switch. Press this switch to turn on/off the cruise control system. The "Cruise control indicator" in the instrument cluster illuminates or goes out accordingly.

Position 3 -  : Cruise cancel switch. Press this switch to cancel the cruise function without clearing the set speed in the memory.

Before You Drive





Position 4 - RES+: Cruise recovery/acceleration switch. If there is a set speed stored, press this switch to resume that speed; press this switch again to accelerate (1 km/h increase per time).

Position 5 - SET-: Cruise setting/deceleration switch. Press this switch to set a speed. Then the cruise function will be enabled and the "Cruise control indicator" on the instrument cluster will turn green from white. If the cruise function is operating, press this switch to decelerate (1 km/h decrease per time).

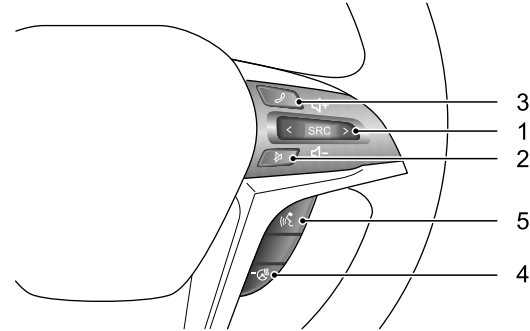
Note: Please refer to "Cruise control system" in the Starting and Driving section for more description about cruise function.

Voice control, bluetooth phone, steering wheel heating switch



Position 1 - : Sound source control switch. Press SRC switch the radio/MP3 player interface; press upward to increase the volume and downward to decrease; short press  to switch to the previous band/MP3 track; long press  to fast-backward; short press  to switch to the next band/MP3 track; long press  to fast-forward.

Position 2 - : Mute switch.

Position 3 - : Bluetooth telephone switch. When Bluetooth is connected, this switch is the Bluetooth phone answering switch. In the general calling state: when there is an incoming call, short press the switch to answer, and long press it to hang up; during the call, short press the switch to hang up, and long press it also

Before You Drive

to hang up; during the dialing, short press the switch to hang up, long press it also to hang up. During the call, if there is a call from a third party, short press the switch to hold the current call and answer the new call; long press it to hang up the new call and hold the original call. After the short-press, you can hang up the original call and answer the new call through the soft button on the entertainment system display.

Position 4 - : Steering wheel heating switch. Press this switch to enable the steering wheel heating function, and the indicator illuminates. Press this switch again to disable the steering wheel heating function.

Position 5 - : Voice wake-up button. Long press this button to wake up the phone's connected voice. Please switch based on the specific vehicle model configuration and functions.

Horn

The horn can operate when the button is pressed, regardless of the ignition switch position.

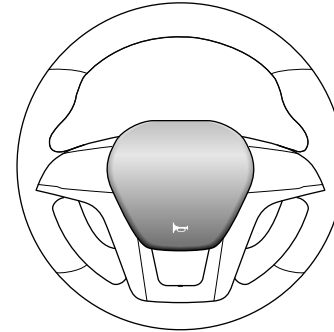

Note: The switch type mentioned above may not applicable to your vehicle, which shall be subject to the actual configuration of the vehicle you purchased.

Before You Drive

Steering wheel adjustment

! Do not adjust the steering wheel position during driving. This is extremely dangerous.

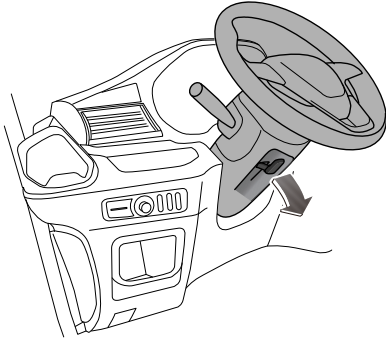

Adjust the steering wheel position to adapt to your driving posture through the following steps:

1 Fully release the steering wheel adjusting handle on the steering column downwards;

2 Grasp the steering wheel firmly with both hands, and move the steering wheel upwards or downwards to adjust it to a proper position;

Note: *If it is still difficult to move the steering wheel to a proper position, place the ignition switch in ON position to unlock the steering wheel, and turn the steering wheel to the straight forward position.*

3 Select a proper driving position, and pull the steering wheel adjusting handle fully up to lock the steering wheel into its new position.

Heating, ventilation and air conditioning (HVAC)

The air conditioning system cools the air and removes moisture and dust e.g. pollen.

The heating system utilizes the heat generated by the engine, so it can heat the air in the vehicle sufficiently only when the engine gets to the normal operating temperature.

The ventilation system ensures the interior ventilation when the vehicle is moving.

The front/rear A/C blower speed selection button is used to control the blower speed.

HVAC is used to control the interior air cooling, heating and ventilation. Fresh air enters the vehicle through the air inlet grille under the windshield and flowing through the A/C filter. Always keep the air inlet grille clean and free of obstructions such as leaves, snow or ice.

Front ventilation

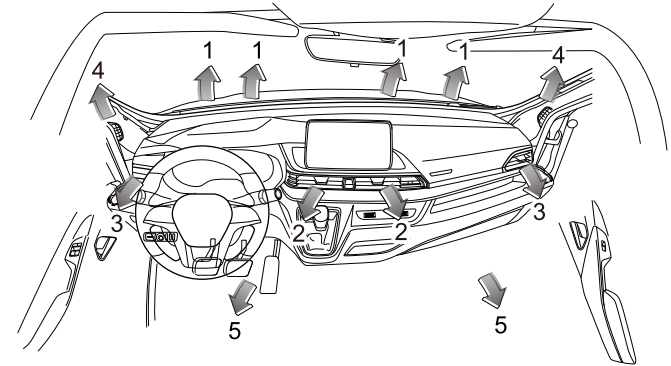

- 1 Windshield vents
- 2 Central vents
- 3 Side vents
- 4 Front door window vents
- 5 Front footwell vents

Before You Drive

Central vents

The direction of air flow can be changed by moving the control lever (1) in the center of the grille upward, downward, leftward and rightward.

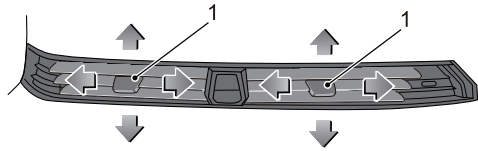

Side vents

The direction of air flow can be changed by moving the control lever in the center of the grille upward, downward, leftward and rightward.

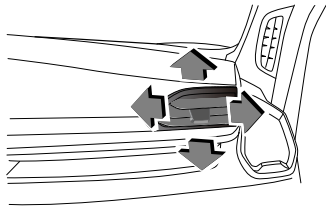

Manual A/C control panel

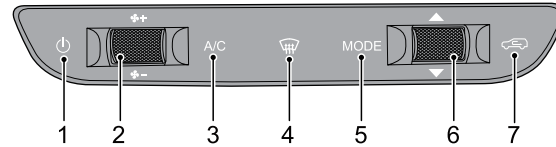

- 1 Power button
- 2 Blower speed regulating roller
- 3 A/C button
- 4 Front defrost button
- 5 MODE button
- 6 Temperature regulating roller
- 7 Internal/external circulation button

Power button

On/Off function.

Only when the vehicle is powered on can the A/C panel be turned on, with the character backlight ON.

Blower speed regulating roller

Adjust the blower speed.

Blower speed regulating roller has eight gears. When rotating up and down, the blower speed increases or decreases. The roller can be turned on, but cannot be turned off.

A/C button

Switch on and off the compressor.

If A/C button is pressed during power-on, the corresponding indicator will illuminate and the compressor is activated (vehicle is started); if the A/C button is pressed again, A/C indicator goes off and the compressor is turned off.

Front defrost button

Switch on the front defrost state.

If the front defrost button is pressed, the corresponding indicator will illuminate, and the default features include: air blowing by external circulation, A/C on, and defrost as the air outlet mode, and the air volume is switched to the 6th gear (if the front defrost button is pressed and the air volume is larger than the value of the 6th gear, this gear is maintained). In the front defrost state, press the front defrost button or other mode buttons again to exit the defrost state.

MODE button

Adjust the air blowing mode. Press the MODE button to switch to the Face mode, Face and Footwell mode, Footwell mode, Footwell and Defrost mode, and Defrost mode in turn.

Temperature regulating roller

Adjust the A/C setting temperature.

With the panel turned on: when the roller rotates down, the set temperature reduces; when the roller rotates up, the set temperature increases; the temperature range is: LO(17°C), 18°C ~ 32°C and HI(33°C). The corresponding temperature of manual A/C does not represent the actual temperature, and it only means the temperature level.

Internal/external circulation button

When the internal/external circulation button is switched, if the internal circulation indicator is on, it indicates that it is in the internal circulation mode; if the indicator is off, it indicates that it is in the external circulation mode.

When the mode is in defrost state, if it is forced to be switched to external circulation state, at this time, it is possible to switch back to internal circulation state manually.

Rear defrost

For models with rear defrost function, the rear defrost touch button is located on the entertainment system display; press the rear defrost button to turn on the rear defrost function, and turning on this function has a rapid defrost and defog effect on the rear windshield.

For models with heated exterior rearview mirrors, the function of heated exterior rearview mirror will be enabled when the rear

Before You Drive

defrost button is pressed, helping remove fog or frost from the surface of the rearview mirror.

Note: *The rear defrost will be automatically disabled after operating for 15 minutes, and the corresponding indicator will go out.*

Front seat heating button

For models with front seat heating function, the front seat heating touch button is located on the entertainment system display. Click on the seat heating touch switch to turn on the seat heating function. When the vehicle is not started, i.e., the engine is not started, the seat heating function is not available.

Electric A/C control panel

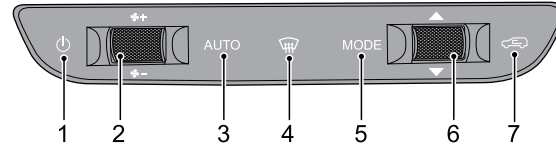

- 1 Power button
- 2 Blower speed regulating roller
- 3 AUTO button
- 4 Front defrost button
- 5 MODE button
- 6 Temperature regulating roller
- 7 Internal/external circulation button

Power button

On/Off function.

Only when the vehicle is powered on can the A/C panel be turned on, with the character backlight ON.

Blower speed regulating roller

Adjust the blower speed.

Blower speed regulating roller has eight gears. When rotating up and down, the blower speed increases or decreases. The roller can be turned on, but cannot be turned off.

AUTO button

This is the automatic air conditioning control mode button.

Press the AUTO button to enter the full AUTO state, each function enters the automatic working state, the AUTO indicator illuminates, the A/C switch on the entertainment system display is turned on, and the circulation indicator goes off. At this time, you can operate the temperature regulating roller to set the temperature required, and the A/C system will automatically adjust the environment in the vehicle according to the temperature set.

In AUTO state, when the air blowing mode button, blower speed regulating roller, A/C switch on the entertainment system screen are pressed, the A/C control panel will exit the full AUTO state, and the AUTO indicator goes out, the corresponding functions will enter the manual control state, and other unoperated functions will remain in auto state.

Front defrost button

Switch on the front defrost state.

If the front defrost button is pressed, the corresponding indicator will illuminate, and the default features include: air blowing by external circulation, A/C switch on the entertainment system display ON, and defrost as the air outlet mode, and the air

volume is switched to the 6th gear (if the front defrost button is pressed and the air volume is larger than the value of the 6th gear, this gear is maintained). In the front defrost state, press the front defrost button or other mode buttons again to exit the defrost state.

MODE button

Adjust the air blowing mode. Press the MODE button to switch to the Face mode, Face and Footwell mode, Footwell mode, Footwell and Defrost mode, and Defrost mode in turn.

Temperature regulating roller

Adjust the A/C setting temperature.

With the panel turned on: when the roller rotates down, the set temperature reduces; when the roller rotates up, the set temperature increases; the temperature range is: LO(17°C), 18°C ~ 32°C and HI(33°C).

Internal/external circulation button

When the internal/external circulation button is switched, if the internal circulation indicator is on, it indicates that it is in the internal circulation mode; if the indicator is off, it indicates that it is in the external circulation mode.

When the mode is in defrost state, if it is forced to be switched to external circulation state, at this time, it is possible to switch back to internal circulation state manually.

Before You Drive

Rear defrost

For models with rear defrost function, the rear defrost touch button is located on the entertainment system display; press the rear defrost button to turn on the rear defrost function, and turning on this function has a rapid defrost and defog effect on the rear windshield.

For models with heated exterior rearview mirrors, the function of heated exterior rearview mirror will be enabled when the rear defrost button is pressed, helping remove fog or frost from the surface of the rearview mirror.

Note: The rear defrost will be automatically disabled after operating for 15 minutes, and the corresponding indicator will go out.

Front seat heating button

For models with front seat heating function, the front seat heating touch button is located on the entertainment system display. Click on the seat heating touch switch to turn on the seat heating function. When the vehicle is not started, i.e., the engine is not started, the seat heating function is not available.

Air conditioning operating tips

- If the vehicle has been parked in direct sunlight, open the windows before operating.
- To clear misted windows on rainy days, operate the defrost button, which can decrease the humidity inside the vehicle timely and effectively. This is most effective during rainy weather and high humidity.
- Insufficient cooling may occur when driving in urban stop-and-go conditions.

Note: If the air conditioning will not be in use for more than one month, run the vehicle at idle speed and turn on the system for more than 10 minutes (once every month, including in winter). This aims to maintain the proper lubrication of the compressor and the seals, so as to extend the service life of the system.

Note: Condensation may be formed on the evaporator when the A/C is operating. So you may find a small pool of water under the vehicle after the vehicle is stopped.

Rearview mirrors

The exterior rearview mirror glasses are convex shaped to broaden the field of view: this makes objects appear smaller and further away than they really are.

Caution

Always check all rearview mirrors for cleanliness and positioning before driving; clean and adjust if necessary.

Exterior rearview mirrors - power adjustment

Turn the switch to L (left) or R (right) to select the rearview mirror to be adjusted. Move the rearview mirror switch towards front/rear/left/right to adjust the rearview mirror lens to tilt towards up/down/left/right to the position required. Turn the switch to the center.

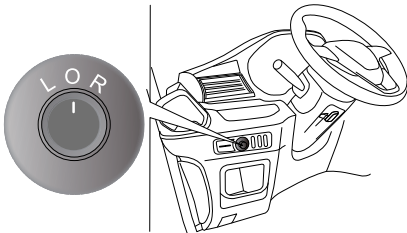

Heated rearview mirrors

For models equipped with heated exterior rearview mirrors, the mirror surface is integrated with a heating element to remove frost or mist from the mirror surface. The heating function of the mirror is activated in conjunction with the heating operation of the rear windshield, which means that the heating function of the exterior rearview mirror only takes effect when the rear defrost button located on the entertainment system display screen is activated after the vehicle is started.

1

Exterior rearview mirrors - manual adjustment

Use hands to move the mirror directly to the desired angle as required.

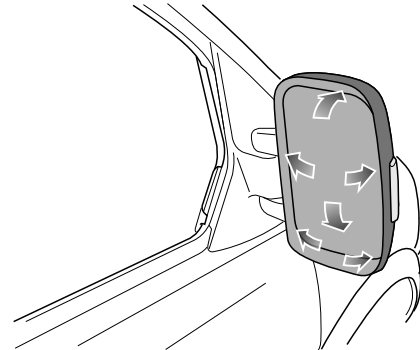

Before You Drive

Foldable rearview mirrors

In order to ensure the safety of pedestrians, exterior rearview mirrors will rotate from their normal mounting positions towards both sides if impacted with a strong force. They can be returned by applying a small amount of force on the rearview mirror frame.

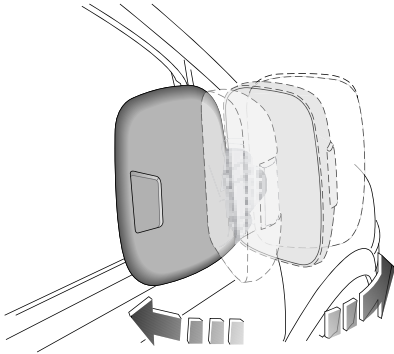

Interior rearview mirrors

Adjust the rearview mirror to give the desired rearward view.

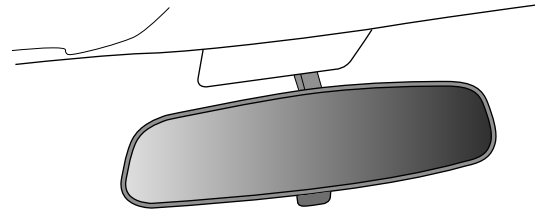

Operate the lever at the bottom of the rearview mirror to reduce reflected glare during night driving.



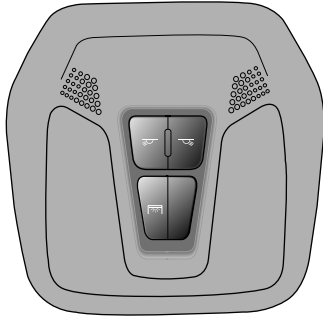

Interior equipment

Roof vanity lamp



Press the left switch  to turn on the left front roof vanity lamp; press the right switch  to turn on the right front roof vanity lamp.

Press the left switch  (switch reset state) again, the left front roof vanity lamp is in Door Control ON state; press the right switch  (switch reset state), the right front roof vanity lamp is in Door Control ON state.

Press the middle switch  to turn on the rear roof vanity lamp.

Press the middle switch  (switch reset state) again, the rear roof vanity lamp is in Door Control ON state.

Touch switch on entertainment system display

When the reading lamp ON mode touch switch on the entertainment system display is in the "AUTO" position, all dome lamps will be on if any door is opened; all dome lamps will be off within about 15 seconds if all doors are closed; when it is in the "Normally Open" position, all dome lamps will be on; when it is in the "OFF" position, the dome lamps will be on with the dome lamp switch status, and off when the doors are opened.

Note: *The roof vanity lamp will go out automatically after approx. 15 minutes any door is opened to avoid battery lack of power.*

Before You Drive

Ashtray

! The ashtray is a fire risk. Putting lit cigarettes or matches in an ashtray with combustible materials can cause a fire. Do not use the ashtray as a waste receptacle.

The ashtray is located beneath the A/C control panel. Open the ashtray by opening its cover.

To empty the ashtray, hold one side of ashtray to remove it.

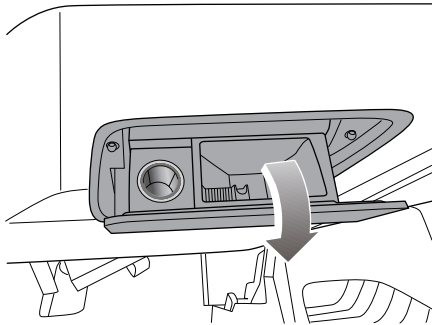

12V power socket

The 12V power socket is located in the ashtray which is beneath the A/C control panel. The 12V power socket mainly provides power connection for external electrical equipment.

Caution

Please do not use the 12V power socket for a long time when the vehicle is powered on but not started, as it may cause the battery to run out of power.

Note: The 12V power socket can supply power to electrical equipment with a power of no more than 120W.

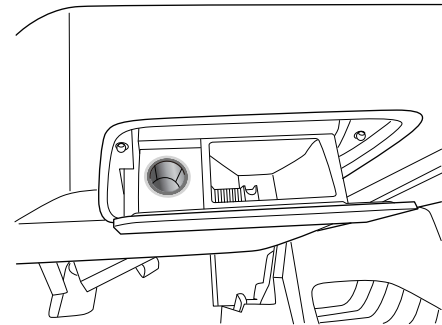

Before You Drive

USB ports

The USB port on the right side of the central vent of the instrument cluster supports audio and video playing, picture browsing, charging and mobile phone interconnection functions. The USB port on the driver side instrument cluster supports charging function. The Type-C port located above the glove box supports charging function.

Note: Functions supported by the USB port may vary with the configuration of on-board entertainment system, please refer to the actual functional configuration of the vehicle.

Note: When the vehicle is not started, do not use the USB port to charge for a long time. This may cause battery loss and affect normal starting of the vehicle.

USB port in instrument cluster at driver side

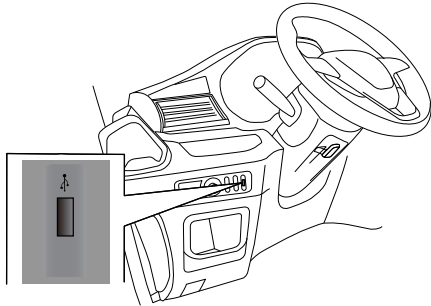

USB port at right side of center vent of instrument cluster

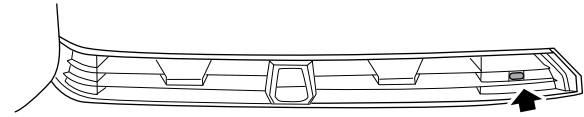

1

Type-C port located above the glove box

Note: It is applicable to the vehicle equipped with the Type-C port. The Type-C port supports PD3.0 and can power devices up to 27W in power.

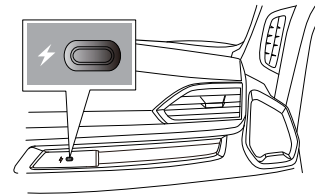

Before You Drive

Cup holder

Cup holders at both sides of instrument cluster

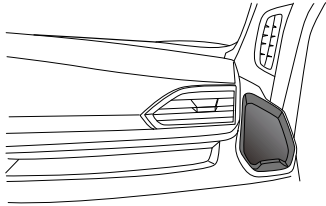

Cup holder at front occupant dual seat armrest

Note: It is applicable to the integral front occupant dual seat and the fixed front occupant dual seat.

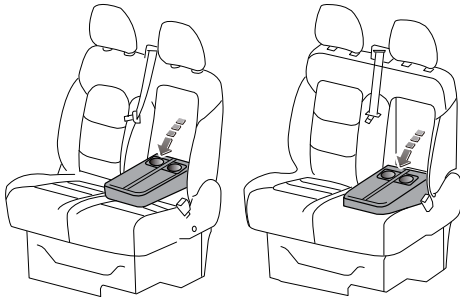

Glove box

! Do not stow sharp, heavy or dangerous objects in the glove box at the occupant side.

Driving with the glove box open can cause injury in the event of an accident or sudden stop. Keep the glove box closed when driving.

Pull back the button at the upper left of the glove box to open the glove box. Close it with a firm push.

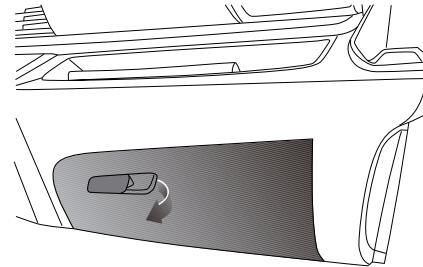

Before You Drive

Sun visors

Both sun visors can be swung up and down to provide a shield through the windshield. In addition they can be pivoted as illustrated to shield through the side windows.

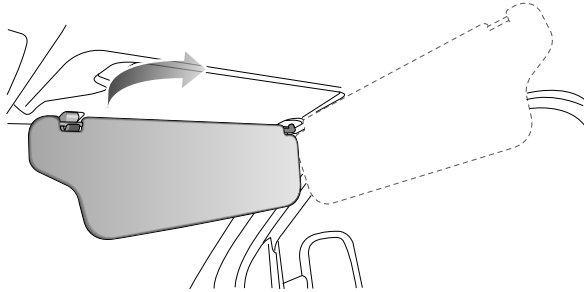

Glasses box

Note: *It is applicable to the vehicle equipped with the glasses box.*

1

The glasses box is located behind the front roof vanity lamp, which is used to hold glasses.

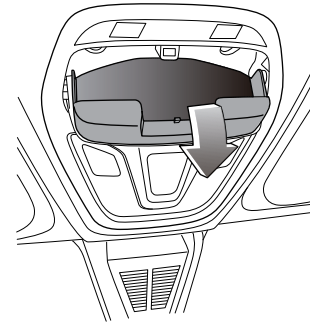

Before You Drive

Vehicle tools

The tools are placed in the storage box at the right front stepwell of the vehicle.

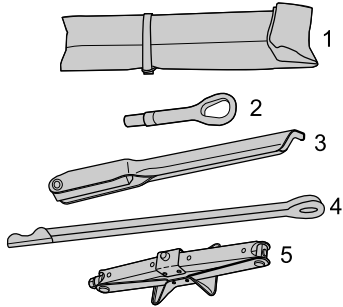

- 1 Driver tool package
- 2 Front towing hitch
- 3 Wheel nut wrench
- 4 Auxiliary rotary post of jack
- 5 Jack

Electric step

Note: *It is applicable to the vehicle equipped with the electric step at the side sliding door.*

When the driver's door is unlocked and the side sliding door is opened, the electric step at the side sliding door automatically extends; Close the side sliding door, and the electric step at the side sliding door automatically retracts.

When the driver's door is closed and locked, the electric step automatically retracts.

Note: *The electric step can only operate normally when the central locking system is unlocked and the vehicle is in P or N gear, and the vehicle speed is less than 3 km/h. When the vehicle is in non P or non N gear, the electric step is always retracted. When the electric step is extended and retracted, if it encounters an obstacle, the anti-pinch function will be triggered, after that the step will be automatically extended or retracted, and this action stops after repeating up to three times.*

Entertainment system

Precautions before use

The contents of this Handbook are simple instructions for the operation of the product. Please read carefully and fully understand the operating instructions accompanied with the entertainment system head unit before you use this product.

 **Please do not install or repair your product without authorization. If the product is installed or repaired by a person who does not receive the training on electronic equipment and auto parts, a dangerous situation may be posed. Never expose the product to any liquid, otherwise short circuit or damage may be caused.**

According to the relevant national regulations, watching videos and related operations are prohibited when driving, for the personal safety of yourself and others. Please do not watch the screen and perform related operations when driving a vehicle.

Please pay attention to all precautions mentioned in this section of the Handbook and strictly follow the operating instructions.

The rear view camera function of the system just serves as a driving assist. Please pay attention to the actual situation.

Caution

- The product shall be kept away from moisture.
- If the product is started for the first time or reconnected after the disconnection of vehicle power supply, the date shown on each interface of the head unit needs to be adjusted manually.
- Be sure to drive safely. Make sure to follow the rules of safe driving and existing traffic regulations.
- Do not operate the product (and the rear view camera function) if it may distract you from safe driving.
- If you have to operate by watching the screen, park the vehicle in a safe place and apply the parking brake.
- Do not set the volume of the product too high, or you will not be able to hear the traffic and emergency signals outside.
- For the sake of safety, some features, such as video playback, will be disabled when driving.
- The system can detect the running speed of the vehicle. When the speed exceeds a certain value, the system will prevent you from watching video while driving. If you want to watch the video, park the vehicle in a safe place and apply the parking brake.
- To prevent the battery from running out, make sure to start the vehicle when using the system.
- The pictures in this Handbook are schematic diagrams which may be slightly different from the real car in details and are for reference only. As for the specific colors and functions of the interface, please refer to the real car.

Before You Drive

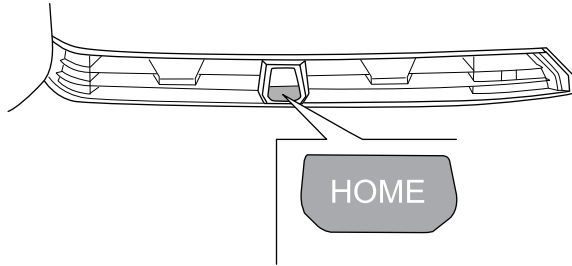

Short press the HOME button to return to the HOME page from other interfaces; if the current page is the HOME page, this action is invalid.

Long press the HOME button for about 10 seconds to restart the entertainment system.

Application center

- 1 On the HOME screen, click the "Application Center" icon ① to expand all application interfaces.
- 2 On the application interface, click the "User Manual" icon ② in the application center to view the instructions of the entertainment system.

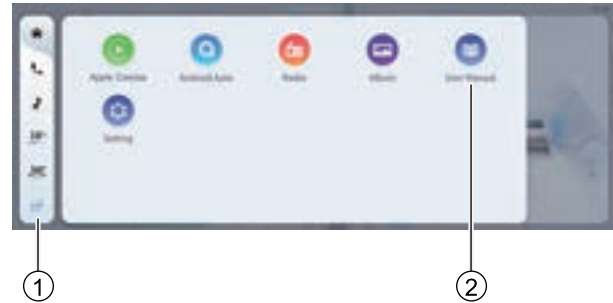

Note: As the entertainment system software will continue to be updated and iterated, the pictures in this manual are only schematic diagrams, which may be slightly different from this vehicle. They are for reference only, and the actual vehicle status shall prevail.

Starting and Driving

- 88 Starting and driving
 - 88 Ignition switch
 - 90 Keyless start system
 - 92 Engine immobilizer
 - 92 Starting/stopping the engine
 - 94 Auto stop/start system
 - 96 Driving
 - 98 Catalytic converter
 - 102 Fuel
 - 105 Urea
 - 106 Manual transmission
 - 107 Electric power steering unit
 - 108 Brake system
 - 116 Cruise control system
 - 118 Parking assist system
 - 124 Driver assistance system
 - 141 Driver monitoring system
 - 143 Tires
 - 145 Loading
 - 146 Trailer towing
-

Starting and Driving

Starting and driving

- Ensure that the daily/weekly maintenance checks have been done as detailed in the section "Maintenance and Service - Owner's Check".
- Check that the seat is in the right position.
- Check that the adjustment of all the rearview mirrors is in place.
- Check that all lights, signal systems and warning indicators operate normally.
- Check that all occupants have correctly fastened seat belts.

Move the ignition switch in "ON" position, and check all warning lamps and gauges operate normally. (Please see "Warning lights and indicators" in the Before You Drive section).

Caution

Be sure you have read the "Before You Drive" section of this Handbook and a good understanding of your vehicle and its equipment before reading this section.

Ignition switch

Keyless start

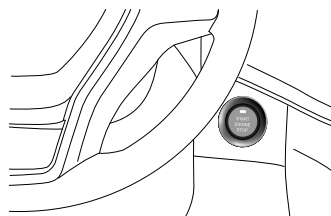

Note: *The vehicle is equipped with an one touch start switch, that is, the Start Stop button. To start the vehicle, the remote key with PEPS feature must be in the vehicle.*

ACC - red light

- Start Failure
In case of an engine start failure, the ignition switch will switch to ACC (N gear).
- Abnormal parking
When the engine is running and the shift lever is not in N position, press this button and the ignition switch will switch to ACC.
- Emergency flameout
When the vehicle speed is higher than 5km/h during driving, press the ignition switch for 3 times continuously or long press it for 3s, the ignition switch will switch to ACC.

Starting and Driving

Note: A red light flashing three times continuously indicates that no valid physical key/bluetooth key has been detected in the vehicle.

ON - green light

When the engine shuts down and the starting conditions are not met, press this switch once, the ignition switch will switch to ON; after the engine is normally started, the ignition switch will switch to ON; when in ON state, all instruments, control devices and circuits can operate.

Note: If the ignition switch is still placed in ACC or ON position after engine shutdown, the battery power will be drained. The vehicle may be unable to start if the battery power drain time is too long.

START - green light

This position is used for starting the vehicle. When the engine shuts down, there is a valid remote key in the vehicle and the starting conditions are met, press and release the Start Stop button, and the engine will be started.

Starting conditions:

- Place the shift lever in N position.
- Depress the clutch pedal all the way down and hold it.

OFF

The engine shuts down when the shift lever is switched to this position. When the shift lever is placed in N position, press this switch and the ignition switch will switch to OFF.

Caution
When the vehicle is close to strong radio antenna signals, there may be an interference effect on the remote door lock system and the Start Stop button will not work.

2

Starting and Driving

Keyless start system

Keyless unlocking

When all doors are locked, enter the sensing area with a remote key and press the micro switch on the door handle, the central lock will unlock automatically. After unlocking, direction indicators will flash twice. If you do not conduct any of the following operations within 30s after that, the central lock will automatically lock again:

- Open any door
- Shift the power supply position to a non-OFF position
- Operate the central lock to unlock/lock

Note: It is feasible to unlock doors with the central unlocking button on the remote key. Press the central unlocking button once, and the central lock will unlock automatically.

Keyless locking

When the driver's door or front occupant door is unlocked, enter the sensing area with a remote key, and then press the micro switch on the door handle. The direction indicators will flash once, meanwhile the alarm horn will ring once for a short time (as appropriate). Then all doors will be locked, meanwhile the vehicle enters the fortification state. In any of the following cases, the doors will not be locked after the micro switch is pressed:

- The power supply switch is placed in non-OFF position

- The remote key is left in the vehicle
- The remote key is not in the sensing range
- The remote key battery is low
- The driver's door is open

Note: It is feasible to lock doors with the central locking button on the remote key. Press the central locking button once, and the central lock will lock automatically.

Keyless start

When the remote key is left in the vehicle and the starting conditions are met, press the start-stop switch once at this time, and then the engine will be started.

Starting conditions:

- Place the shift lever in N position.
- Depress the clutch pedal all the way down and hold it.

Note: If the starting conditions are not met, every time you press the start-stop switch, the power supply positions will be switched among OFF, ACC and ON in a cycle. If the remote key is not in the vehicle, after depressing the brake pedal, the indicator lamp will not go on; the power supply position switching or ignition action will not be performed after the start-stop switch is pressed.

Backup starting

When the remote control battery is low, the keyless entry function will fail, but you still can start the engine. Open a door with the mechanical key and enter the vehicle. At this time, the system may be in IMMO state and the alarm may be triggered, which is a normal situation.

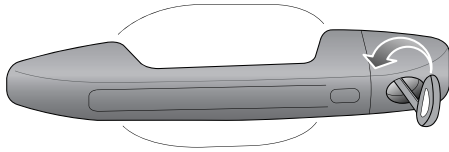

On the premise that the starting conditions are met, place the key flat on the lower protective plate marked in the middle of the dashboard, and press the Start Stop button to start the engine.

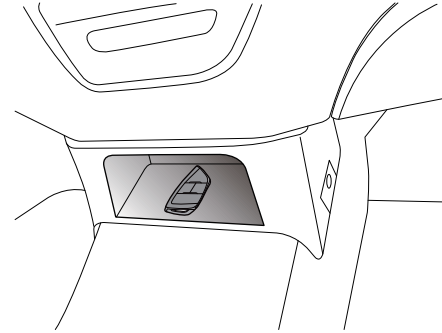

Emergency Start and Shutdown

If you need to shut down the vehicle immediately during driving due to an emergency, there are two methods to shut down the engine:

- 1 Keep pressing the Start Stop button within 3s;
- 2 Press the Start Stop button for 3 consecutive times.

Starting and Driving

Engine immobilizer

Key

If your vehicle is equipped with electronic chip engine immobilizer, the key has been coded electronically for your vehicle. The coded key can be used for the corresponding vehicle only. Only the keys attached with the vehicle can start your engine.

When the immobilizer is effective, any illegal behavior to start the engine will be prohibited.

Enable/disable

For vehicles equipped with a keyless start system, when pressing the start stop switch on the dashboard to the "ON" position, if the authentication is successful, the "engine immobilizer warning light (yellow)" on the instrument cluster panel will keep off. If the warning light flashes, it is shown that the immobilizer goes wrong and the engine cannot be started. Contact Our Service Dealer for service immediately.

Note: *The remote key contains a microchip which guarantees the fault-free data exchange between the key and the vehicle. Do not shield the key with a metal object (such as another key). Prevent it from severe impact. The quantity of keys hung on the key ring shall not exceed 1.*

Starting/stopping the engine

Starting



 **CO is a harmful gas and may cause coma, even death. Avoid inhaling vehicle exhaust because it contains colorless, odorless and tasteless CO. Do not start the engine or keep the engine running in an airtight and unventilated place. If you find there is exhaust in the vehicle, find out the cause as soon as possible and handle it. If you have to operate in this kind of environment, please open all windows completely.**

Check and make sure that the parking brake has been activated and the shift lever is in N gear. All unnecessary electrical equipment shall be shut down.

Place the ignition switch in "ON" position, and wait for the "glow

plug indicator (yellow)"  on the instrument cluster to go off. Depress the clutch pedal and hold it, but do not press on the accelerator pedal. Press the start-stop switch once at this time, and then the engine will be started. After the engine begins running, release the start-stop switch immediately, and the ignition switch will automatically return to "ON" position. When the engine is running, check to ensure that the "battery

Starting and Driving

no-charge warning light (red)"  and "oil pressure warning light (red)"  on the instrument cluster go off.

Note: During starting, do not keep the starter running for 20s above. If the engine is not started, wait for at least 30s after turning off the ignition switch and try again. The starter will stop automatically after running for 20s.

Note: If the engine management system fails, the "engine malfunction warning light (yellow)"  on the instrument cluster may flash or continue to stay on, and the engine may not be able to start (see "Self-protection mode" in this section).

Caution

Do not allow the engine to run above the idle speed within 30 seconds after starting, so as to ensure that the turbocharger bearing can be adequately lubricated before running at high speed.

Warm-up

When the engine temperature is relatively low, there will be a poor effect if the engine is warmed up with the vehicle in stationary state. It is recommended to drive the vehicle as soon as possible after the engine is started.

Self-protection mode

In case of an engine fault which may affect the driving performance during driving, the engine system will enter the "self-protection mode". In this case, the "engine malfunction warning light (yellow)" on the instrument cluster will start flashing or stay on. Please contact Our Service Dealer for service immediately.

Stopping

Turn the ignition switch from "ON" to "OFF" position to shut down the engine.

Enable the parking brake.

Caution

Keep the engine idling for 10s before shutdown, in order to ensure the turbocharger bearing is fully lubricated during the deceleration.

Starting and Driving

Auto stop/start system

Note: *It is applicable to the vehicles equipped with auto stop/start system.*

Basic service conditions

The auto stop/start system helps save fuel and reduce carbon dioxide emissions. When using the auto stop/start system, the engine automatically shuts down if the vehicle is stationary in case of a red light. The ignition switch remains ON during the shutdown phase. The engine starts again automatically when needed. The auto stop/start system will be automatically activated with the ignition switch turned on.

Basic service conditions of the auto stop/start system:

- The driver's door has been closed.
- The driver has fastened his seat belt.
- The engine hood has been closed.
- The vehicle has been running at a speed of above 10km/h since the last stop.

Caution

Please always keep the auto stop/start system OFF when wading through water.

Stopping and starting the engine

Vehicles with manual transmissions

When the vehicle is in stationary state, please shift into the idle gear and release the clutch pedal, and then the engine will be shut down. At the same time, the "auto stop/start system

indicator (green)"  in the instrument cluster will be lit.

The engine will start again if the clutch pedal is depressed. The indicator goes out.

Caution

Please depress the brake pedal when the engine is OFF to prevent the vehicle from moving. If the engine auto stop/start system OFF switch is pressed during the shutdown phase, the engine will start automatically. If the driver's door is opened or the driver's seat belt is taken off, the engine will not start automatically. If the engine needs to be started, please switch the shift lever to N gear and start the engine through the start-stop switch.

Starting and Driving

Note

Conventional auto stop/start operation may be interrupted due to different system reasons.

The engine has not been shut down.

Prior to and during each shutdown phase, the system checks whether certain conditions have been met. The engine will not shut down under the following conditions:

- The engine has not reached the minimum temperature to start/stop the system.
- The windshield is being requested to defrost.
- The charging status of the battery is too low.
- After the replacement or reconnection of the battery, the vehicle is not locked for more than 4h.
- The shift lever is in the R gear.
- The slope is very steep.
- Insufficient brake vacuum.

When the start-stop conditions are not met, the "auto stop/start

system indicator (white)"  will be lit.

The engine starts automatically again.

During the shutdown phase, the normal start/stop operation will be interrupted under the following cases. The engine starts again without the driver's operation.

- The windshield is being requested to defrost.
- The charging status of the battery is too low.

- The brake vacuum decreases.

If the conditions for intelligent start/stop operation are met again, the engine may be shut down again.

Caution

- If you do not want to use the system, you can turn it off manually. When the engine auto stop/start system OFF switch is pressed, the start/stop system will be turned off, and a dialog box "Stop/Start System Off" will appear in the instrument cluster.
- When the "auto stop/start system indicator (yellow)"  on the instrument cluster is lit, the auto stop/start system has a fault! The functions are not available.
- There is a fault with the auto stop/start system. Please contact our Service Dealer for troubleshooting.

Starting and Driving

Driving

Running-in of new vehicle

This vehicle requires no deliberate "running-in", but in order to enhance the long-term running performance, we strongly recommend the following:

Within the first 3,000km:

- Avoid driving too briskly and vary the speed frequently.
- Never depress the accelerator pedal to the lowest position at any gear.
- Do not keep the engine run slowly with difficulty at any gear.
- If possible, avoid undue heavy braking.

After the mileage reaches 3,000km, you can gradually increase the vehicle speed to the maximum admissible speed.



Avoid using high engine speed to protect the engine, reduce fuel consumption, lower engine noise level and protect the environment.

Driving



When driving, never place any portable container with fuel on the vehicle. Otherwise it may leak and a fire may result.

Caution

During driving, do not place your foot on the clutch pedal for rest; otherwise the clutch may be worn/damaged.

When driving on a risky road covered with water, snow, ice, mud, sand, etc., please:

- Slow down, drive with care and reserve longer brake distance.
- Avoid any sudden operation during braking, steering or acceleration.
- Apply sand or other anti-skid material under the drive wheels or install tire chains on them to provide the traction needed when the vehicle gets stuck in ice, snow or mud.

Starting and Driving

Skid

If your vehicle skids on a wet road, you cannot control the vehicle due to the decrease of friction force between the road and tires. Different road surfaces, tire inflating pressures and vehicle speeds may lead to skid. Skid is very dangerous.

The optimum method to stop skid is lowering driving speed and keep cautious when you feel the road is wet enough.

Wading driving

In order to avoid damage to your vehicle, when passing a road with gathered water, please:

- Confirm the water depth before the wading driving. The maximum wading depth of the vehicle is 30cm.
- Do not drive faster than 30km/h.
- The wave caused by front vehicle and head-on vehicle may exceed the maximum allowed wading depth.
- To avoid damage to your vehicle, please drive away from the flooded road as soon as possible.

Caution

If the vehicle stalls in water due to an accident, DO NOT restart the engine. Please contact Our Service Dealer immediately.



Water and mud can affect the braking system and lengthen braking distance, leading to an accident!

- Slightly depress the brake pedal to keep brake parts dry and recover performance.
- Do not conduct an emergency brake when passing a slippery road.

Note: *The engine, drive system, transmission and electronic system of the vehicle may be severely damaged after the vehicle drives on a road with gathered water. Salt water is corrosive. The on-board components soaked by salt water must be washed with clean water.*

Ramps and ferries

When negotiating sharp or severely inclined ramps, e.g. ferries, exercise caution to avoid damage to the underside of the vehicle.

Starting and Driving

Catalytic converter

 **The catalytic converter will release a lot of heat (even within a short time after engine shutdown), which may cause a fire. Do not operate or park the vehicle on any flammable object (such as paper, dry grassland or dry fallen leaves).**

When the engine is running or after it is shut down within a certain period, and before the catalytic converter cools down, prevent any body parts from contacting the exhaust system.

The catalytic converter installed in the exhaust system is used for reducing exhaust pollution.

Caution

In order to protect the catalytic converter from being damaged, the following precautions must be observed:

- Diesel oil should be used. If gasoline is added, the company will not bear any responsibility. If gasoline is accidentally filled, you should immediately contact Our Service Dealer for maintenance. Do not start the engine.
- If the vehicle is difficult to start or driving performance degrades during driving, please drive the vehicle to a nearby Our Service Dealer for service.
- Do not drive under extremely low fuel level. The engine may be unable to start during driving under fuel exhaustion.
- Do not start the vehicle by pushing or trailing it.
- Do not shut down the engine during driving.

Precautions for Use of DPF (Diesel Particulate Filter)

The main function of DPF is to collect particles in vehicle exhaust, and to remove particles collected in DPF through active and triggered regeneration in a certain period to achieve the function of recovering DPF to collect particles. Active regeneration refers to the function of the engine to automatically start and recover DPF to collect particles in vehicle exhaust according to actual working conditions. Triggered regeneration refers to the regeneration that the current working conditions of the engine cannot meet the active regeneration conditions and requires human intervention.

Switching regeneration of DPF one-key regeneration

Instrument alarm prompt

Level 1 alarm prompt: "Please drive at high speed or safely trigger DPF regeneration in situ" is displayed on the instrument cluster for 9 seconds, and the buzzer prompts three times. the "DPF warning light (yellow)" on the instrument cluster

stays  ON.

Level 2 alarm prompt: "Ensure safety, and immediately trigger DPF regeneration in situ" is displayed on the instrument cluster for 9 seconds, and the buzzer prompts three times. It can be temporarily canceled by pressing the OK button on the steering wheel or the SET button on the combination switch for a short time. If the alarm state does not change within 2 minutes after the alarm pop-up disappears, the alarm will be triggered again,

and the "DPF warning light (yellow)"  on the instrument cluster will flash at a frequency of 1 Hz.

During the process of regeneration, "xx% of DPF regeneration has been completed, please wait patiently" is continuously displayed on the instrument cluster, and the "DPF (Diesel Particulate Filter) Warning Lamp (Yellow)" on the instrument

cluster flashes  at a frequency of 0.5 Hz.

The instrument cluster of regeneration completion displays "DPF regeneration in situ is completed and normal driving is available" for 3 seconds, and a buzzer prompts once.

The instrument cluster that cannot accept regeneration operation displays "DPF cannot be regenerated due to the reason of xx, please refer to the Owner's Handbook for details" for 9 seconds, and a buzzer prompts once.

The specific reasons why DPF can not be regenerated are as follows:

- 0: The engine is not in Normal operation mode
- 1: Coolant is not in the allowable temperature range
- 2: The oil temperature is not within the allowable temperature range.
- 3: The barometric pressure is not within the allowable pressure range
- 4: The fuel temperature is not within the allowable temperature range
- 5: Insufficient battery voltage
- 6: The clutch is depressed
- 7: Not in N gear
- 8: The vehicle speed is not equal to zero

Starting and Driving

- 9: The engine speed is not within the allowable range
- 10: The internal torque is not within allowable range
- 11: The accelerator pedal is not within the allowable range
- 12: The upstream temperature of DPF is not within allowable range 1
- 13: The upstream temperature of DPF is not within allowable range 2
- 14: The upstream temperature of DOC(Diesel Oxidation Catalyst) is not within the allowable range 1
- 15: The upstream temperature of DOC(Diesel Oxidation Catalyst) is not within the allowable range 2
- 16: DPF particles are not higher than the set limit value
- 17: DPF-related faults
- 18: Engine-related faults
- 19: The maximum allowable regeneration time comes
- 20: The upstream temperatures of DOC(Diesel Oxidation Catalyst) and DPF fail to reach within the allowable range 1 target value
- 21: The upstream temperatures of DOC(Diesel Oxidation Catalyst) and DPF fail to reach within the allowable range 2 target value
- 22: The Maximum Allowable Temperature 1 of upstream DPF is exceeded
- 23: The Maximum Allowable Temperature 2 of upstream DPF is exceeded
- 24: The Maximum Allowable Temperature 1 of upstream DOC(Diesel Oxidation Catalyst) is exceeded
- 25: The Maximum Allowable Temperature 2 of upstream DOC(Diesel Oxidation Catalyst) is exceeded
- 26: Regeneration command of service station has not been sent
- 27: The brake is depressed

Switching regeneration steps

- 1 Stop the vehicle, put the manual transmission in N gear, enable the parking brake, and turn off the ignition switch for 2 minutes.
- 2 Start the vehicle;
- 3 Press the one-key regeneration switch and hold it for 2 seconds, then DPF regeneration will begin.

Note: If the engine speed rises to 2,000 rpm, the regeneration trigger is successful; otherwise it is unsuccessful. Turn off the ignition switch and wait for 2 minutes, and then operate again according to the above steps. After regeneration starts, unless you have to drive, please stay in N gear and keep the vehicle in stationary state. Do not perform other operations (e.g. depressing the brake pedal, the clutch pedal, the accelerator pedal, etc.) until the engine speed returns to idle speed.

Caution
DPF regeneration temperature is very high, please park the vehicle in an open and ventilated place, and make sure there are no inflammables (e.g. hay, oil, etc.) around when using. If it cannot be regenerated successfully for several times, please go to Our Service Dealer for processing.

Starting and Driving

Conditions of regeneration

- The DPF is overloaded, and the particle value exceeds the set value (the instrument panel has level 1 and level 2 alarms).
- The water temperature is above 40 degrees Celsius.
- No DPF-related function error.
- The vehicle speed is 0 and the gear is N.

Possible causes of regeneration failure

- The clutch pedal is depressed.
- The gear is not in N.
- The vehicle is not stationary state (The vehicle speed is not zero).
- The accelerator pedal is depressed.
- The brake pedal is depressed.
- The engine conditions are not satisfied (for example, the water temperature is too low and the exhaust temperature is too high).
- The engine has DPF-related fault(s).
- The regeneration steps were not followed.

Regeneration steps for high load driving

- 1 Carry out high-load conditions cycles, such as high-speed driving (vehicle speed is maintained at 80km/h and above);
- 2 Drive the vehicle for about 30 minutes.

Special driving conditions

Under the following circumstances, the vehicle has almost no triggered regeneration, and the efficiency of active regeneration is generally low or even zero, requiring the attention of the driver to try the best to avoid:

- Repeatedly start and stop the vehicle.
- Operate the vehicle at a low speed and a low load for a long time.
- The vehicle idles for a long time in stationary state.

Caution

The cumulative amount of DPF carbon deposition will increase after a long time idling. If your vehicle needs to keep operating at idle speed for a long time, when the active regeneration function of the vehicle is enabled, please depress the accelerator actively to make the engine speed reach 2,000 ~ 2,500 rpm to assist regeneration.

Starting and Driving

Fuel

Refueling



It is prohibited to mix diesel with engine oil, gasoline, kerosene, paraffin, water or other liquids for use, which may damage the fuel system.

Do not fill so much fuel that the fuel can be seen in the filling port or overflows, leading to a fuel contact risk for you and other persons.

Please select the required fuel according to the tag on the filler port of fuel tank. See “Main engine parameters” in General Technical Parameters section.

Caution

- It is recommended to use high-quality fuel free of additive or other engine cleaner.
- If you accidentally fill it up with gasoline, contact Our Service Dealer for service immediately. **DO NOT** start the engine. If the engine with gasoline is started, the fuel system components will be damaged severely. This kind of damage is not covered by warranty.



In order to prevent fuel from overflowing, please stop refueling when the fuel filler nozzle is automatically closed. If you continue refueling at this time, the fuel tank will be overfilled and the fuel will overflow when the outdoor temperature is high or the vehicle makes a turn.

Starting and Driving

Fuel filler cap

Open the driver's door and then the fuel filler door.

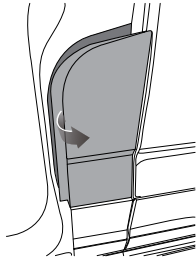

Turn the fuel filler cap counterclockwise to remove it, then refuel the tank. After the refueling, turn the fuel filler cap clockwise to tighten it, then close the fuel filler door.

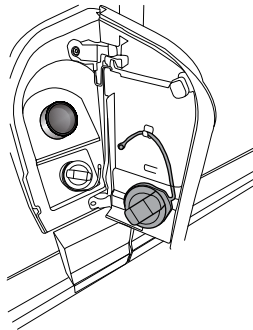

Saving fuel

Fuel consumption is mainly influenced by three factors:

- Vehicle maintenance mode
 - Regular vehicle maintenance shall be done by Our Service Dealer in accordance with Warranty & Service Handbook.
 - Check the tire pressure periodically.
- Vehicle driving mode
 - Avoid high-speed driving at low gears (the gear shall be shifted), otherwise the vehicle will consume more fuel.
 - Frequent cold start and/or short-distance driving consumes a lot of fuel.
 - The vehicle will consume a lot of fuel when driving on a blocked or winding road or driving uphill.
 - Pre-consider possible risks to avoid emergency brake.
 - Make sure the parking brake is released completely during driving.
- Vehicle load
 - The heavier the load is, the higher the fuel consumption is. Do not add unnecessary load.

Starting and Driving



The following driving precautions will help you to save fuel and protect the environment.

- Ensure the tire pressures are correct.
- Avoid accelerating immediately after starting, and avoid depressing the accelerator pedal all the way down.
- The driving time at low gears shall not be excessively long.
- Try to use the top gear when the engine runs steadily.
- Pre-consider possible barriers, crossroads, sharp bends or traffic lights, and adjust vehicle speed correspondingly in advance.
- If it is predicted that the traffic may be blocked for a long time or it is required to wait for a long time, please shut down the engine if allowed by safety conditions.

Precautions for cold weather



It is prohibited to use lamp oil (kerosene) as the additive. It is very dangerous to add gasoline to the fuel.

In order to reduce possible problems which may occur in cold weather, please consider the following suggestions:

- Please use the fuel conforming to winter requirements.

- Park the vehicle in an area where the fuel temperature can be maintained above -9°C .
- Fill the fuel tank after driving every day. This practice will reduce the possibility of fuel condensation and accordingly reduce the influence of water generated due to temperature rise after condensation on oil quality.
- Replace the element of fuel filter according to the recommended time interval.
- Maintain the battery power in normal state.

Caution

Additive may degrade the lubricating property of fuel, accelerating wear and damage of engine and fuel injector.

Fuel hose

Hoses are used partially in the fuel pipeline; aging and other phenomena are unavoidable after being used for a long time. Please be sure to check the fuel hose regularly according to Warranty & Service Handbook, and replace it every 10 years/160,000km.

Starting and Driving

Urea

Note: *It is applicable to the vehicle equipped with a urea filler.*

When the "urea warning light (yellow)" in the instrument cluster is lit, it is needed to timely supplement the urea solution for the vehicle. The urea solution used for vehicles needs to meet the ISO 22241-2:2019 standard.

Urea filling

! **It is forbidden to mix urea with engine oil, kerosene, paraffin, water or other liquids, which may cause damage to the urea system. The rated volume of the urea tank is 20.3L. It is recommended to use a standard urea gun for filling. 2 times of extra filling is allowed at most after the gun jumps. If other simple tools are used for filling urea, the user needs to fill the urea according to the estimated urea surplus. Do not fill the urea too full, so that it can be seen or overflowed from the filling hole, thus putting yourself and others at risk of urea exposure.**

Open the driver's door and then the fuel filler door.

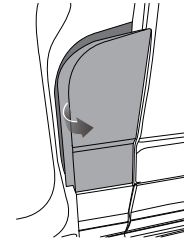

2

Turn the urea filler cap counterclockwise to remove the urea filler cap for urea filling. After filling, tighten the urea filler cap clockwise, and then close the filler door.

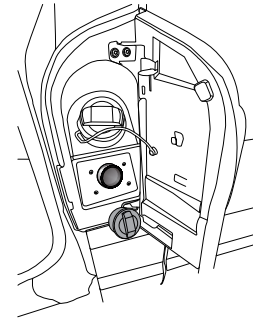

Note: *The color of the urea filler cap is blue, and the text mark on the cap is AdBlue.*

Starting and Driving

Manual transmission

Gear shifting

During the gear shifting, depress the clutch pedal completely, and then move the shift lever. After the gear shifting, release the clutch pedal slowly.

The shift lever knob is marked with all gears.

6-speed manual transmission

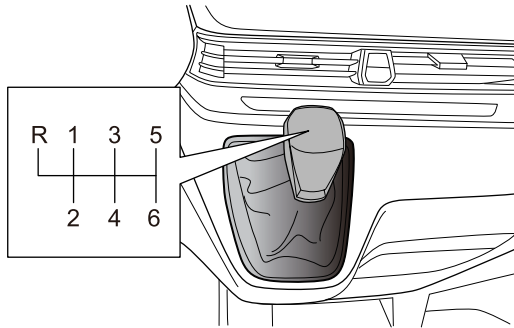

6th gear: Completely push the shift lever to the right by the force greater than the spring stress, and then push it to the bottom. When shifting to the 5th gear, do not apply a lateral pressure towards left, otherwise the gear may be shifted to the 3rd gear by accident. Then the engine will overspeed as a result.

Note: It is not possible to switch the shift lever directly from 6th gear to reverse gear (R).

Reverse gear (R): Lift the pulling tube on the shift lever from N position, and completely push the shift lever to the left by the force greater than the spring stress, and then push it to the top.

Note: It is only necessary to lift the pulling tube on the shift lever when shifting into/out of the reverse gear (R).

Caution

Before shifting into/out of R gear, the vehicle must come to a full stop. Upshift must be done in sequence. It is prohibited to start off with the 2nd gear. Transmission shall not be shifted to N gear for coast down. It is prohibited to shift to N gear, especially when the vehicle drives downhill, so as to prevent the burning damage of the synchronizer and various types of bearings.

Electric power steering unit



If the electric power steering fails or cannot operate, the steering will appear very heavy, which will affect driving safety.

The electric power steering system only works when the vehicle is running. The system operates via a motor with assistance levels automatically adjusted based on vehicle speed, steering torque and steering wheel angle.

The electric power steering system has the advantages of simple structure and energy saving. Compared with the traditional hydraulic power steering system, the electric power steering system only needs energy in actual steering, so that power loss can be reduced in this operating way of power consumption according to the need.

Caution

When the electric power steering system operates, holding the steering wheel on full lock for long periods will result in a reduction in power assistance and cause a heavier feel to the steering.

EPS (electric power steering) system MIL

See “Warning lights and indicators” in Before You Drive section.

If the battery is disconnected or lacks power seriously, this light may illuminate. At this point, fully turn the steering wheel to the left (with appropriate force) then the right, and finally return the steering wheel to the center, thus the system initialization is completed, and the light will go out.

Starting and Driving

Brake system

Service brake

Dual brake hydraulic system

 A failure in one of the hydraulic pipelines will be indicated by illumination of the "braking system

warning light (red)"  on the instrument cluster while driving; it will result in increased brake pedal travel and effort, longer braking distance and may cause the vehicle to pull to one side. Do not pump the brake pedal in an attempt to restore pedal pressure. If there is pressure failure in one of the brake pipelines the cause must be investigated. **IMMEDIATELY bring the vehicle carefully to a halt. You should contact our Service Dealer immediately. Do NOT drive the vehicle.**

Should one of the hydraulic pipelines fail the other circuit will continue to function.

General state

 Always ensure that floor mats or other objects do not disturb brake pedal movement.

Never rest your foot on the brake pedal as this may overheat the brakes, reduce their efficiency and cause excessive wear. If brake pads/shoes have worn excessively, a squealing or screeching noise will be heard when the brakes are applied, and braking efficiency will be affected. Contact our Service Dealer for service as soon as possible.

If the engine stops running due to some causes, brake booster will stop working after 2 pedal operations; to achieve the expected brake effect, a larger force shall be applied on the pedal. In these circumstances the braking distance may be longer.

If the vehicle is not in regular use or is garaged for long periods the efficiency of the braking system could be impaired. Contact our Service Dealer for service as soon as possible.

Wet state



Driving in heavy rain and slushy roads will considerably reduce braking efficiency. At this time, keep safe distance from other vehicles and gently depress the brake pedal intermittently to dry the brake friction components. In severe wet weather this drying process may need to be repeated every few miles.

In winter ice can form or salt may accumulate on the brake pads and discs. Ice and salt accumulation will be cleaned off after intermittently light applications of the brake pedal.

Descending steep hills



Overheating the brakes will reduce braking efficiency and may also cause the vehicle to pull to one side.

For a steep slope which requires to apply the brake constantly, a lower gear shall be selected before driving downhill to reduce the required brake force.

ABS (Anti-lock Brake System)

Your ABS prevents the road wheels from locking under emergency braking; thereby helping you to maintain steering control. No special driving technique is needed.

Under normal braking (where sufficient road surface friction exists to prevent wheel lock), the ABS will not be activated.

An integral feature of this braking system is Electronic Brake Distribution (EBD), which is used to optimize the braking force at the rear wheels under full load condition.

Important rules for emergency brake with ABS On:

- 1 Depress the clutch pedal and then completely depress the brake pedal.
- 2 Bypass the obstacle. No matter how much brake force is used, you can always maintain the control on direction.

Starting and Driving

ABS in action



ABS may not be able to shorten the brake distance, depending on road surface conditions, brake distance may vary significantly. In fact, when the vehicle without ABS drives on some roads (e.g., gravel road or snowy road), the brake distance may be shorter.

ABS cannot overcome some physical limitations of stopping your vehicle in too short a distance, cornering at high speed, or aquaplaning, i.e. where a layer of water prevents adequate contact between the tires and the road surface.

ABS can better protect yourself and other road users from unnecessary risks. You still have a duty to drive within normal safety margins, having due considerations for the road surface, weather and traffic conditions.

If the force of your braking should exceed the available adhesion between the tires and the road, causing one or more wheels to lock, then ABS will automatically come into operation. You will hear the sound of a rapid pulsation which will also be felt through the brake pedal.

Even when making emergency braking on a slippery road surface, be sure to depress the clutch pedal and fully depress the brake pedal. ABS is activated immediately; it constantly

monitors the speed of each wheel and varies the braking pressure to each according to the amount of grip available.

This prevents the wheels from locking and enables steering control to be maintained.

Precautions for driving a vehicle with ABS

- In case of emergency braking, depress the clutch pedal, meanwhile fully depress the brake pedal.
- Under normal braking, apply steady pressure to the brake pedal - DO NOT PUMP IT.
- Remember that steering control will always be available during braking.
- The availability of ABS does not eliminate the dangers of driving too close to the vehicle in front, aquaplaning, excessive cornering speeds, etc.
- ABS does NOT guarantee shorter braking distances.
- Do not be alarmed if you hear and feel a pulsing at the brake pedal. This is normal and indicates that the ABS is in operation.

ESP (Electronic Stability Program)

ESP function

ESP covers the functions of ABS, EBD, TCS, VDC, EBA, RMI and HAS.

ESP Indicator on the instrument cluster flashes when the ESP is operating. You may hear some noise or feel the vibration of brake pedal, which is normal.

When the ignition switch is placed in "ON" position, "ESP



indicator (yellow)" will illuminate and go off after several seconds. In normal driving conditions, ESP indicator keeps off, and ESP is in monitoring state. When the ESP indicator blinks, it indicates ESP is operating. You may hear some noise or feel the vibration of brake pedal, which is a normal phenomenon. In case of ESP failure, ESP indicator will stay On. Please take the vehicle to Our Service Dealer for ESP inspection.

ESP can be turned off with ESP OFF switch, and when ESP



function is turned off, "ESC OFF indicator (yellow)" illuminates and only ABS and EBD functions are available.

EBD (Electronic Brake-force Distribution)

EBD automatically detects the grip conditions between wheels and ground, distributes the brake force optimally to 4 wheels, so as to improve brake efficiency and driving stability.

TCS (Traction Control System)

TCS automatically controls the driving force at the start-off and acceleration to prevent wheels from spinning, so as to maintain the driving stability.

VDC (Vehicle Dynamics Control)

VDC is an advanced computer system, which can help you to control the vehicle driving direction in severe driving conditions. When the computer detects the deviation between the expected driving route and the actual driving direction, VDC system may selectively apply brake pressure on one or more brakes of the vehicle so as to keep the vehicle driving in the direction commanded.

EBA (Electronic Brake Assist)

In case of an emergency, the force applied by a driver on the brake pedal is usually insufficient. EBA can identify this rapid action with insufficient force on the brake pedal and automatically establishes a brake pressure up to the lock level to shorten the brake distance greatly.

RMI (Roll Movement Intervention)

RMI can identify the vehicle rollover trend as early as possible by monitoring the turning angle of steering wheel and lateral acceleration, and apply braking to one or more wheels to prevent the rollover to the greatest extent.

Starting and Driving

HAS (Hill-start Assist System)

When the vehicle drives uphill, HAS can prevent the vehicle from sliding backwards after the driver releases the brake pedal. The driver has up to 1.5s to move his foot from the brake pedal to the accelerator pedal for hill-start.

Precautions for driving a vehicle with ESP

ESP can detect and analyze vehicle conditions, and take preventive measures by correcting wrong driving operation. However, anything has its limit and no safety device is absolutely safe if the driver blindly drives the vehicle over-speeding.

EPB (Electronic Parking Brake)

The EPB (Electronic Parking Brake) switch (Ⓟ) is located on the steering wheel side of the instrument panel, which is used to apply or release the parking brake.

Instructions before Using EPB

- The EPB can be used as long as the ignition switch is in ACC/ON position. Do not operate the EPB switch repeatedly when the vehicle is not running to prevent excessive discharging of the battery. The EPB cannot be applied or released when the battery is low.
- The EPB can prevent accidental slipping when starting off on a slope. The EPB will automatically release only when the vehicle traction is greater than the sliding force.
- When the normal brake of the vehicle fails, the emergency braking function can still stop the vehicle. See "Emergency Braking Function" in this section for details.
- Minor noise may be heard when applying or releasing the electronic parking brake. This is normal, please rest assured.
- When the vehicle is powered off, the applied parking brake cannot be released, and the released parking brake cannot be applied, please connect an external power supply.
- If the "EPB (Electronic Parking Brake) indicator (red)"



does not turn on or off when you operate the EPB switch, or the "EPB (Electronic Parking Brake) malfunction

Starting and Driving



indicator (yellow) illuminates and the EPB cannot be released through normal operation, please contact our Service Dealer.

- Do not apply the electronic parking brake on the road with a slope greater than 20%, otherwise the vehicle may slip. If the EPB cannot be fully applied when parking on a road greater than the defined slope, the driver can prevent vehicle slipping by depressing the brake pedal.

Parking

Manual hold

- 1 The ignition switch is in "ON" position or the engine is running.
- 2 Keep the vehicle stationary.
- 3 Pull up the EPB switch (Ⓢ) to apply the parking brake. If the "EPB (Electronic Parking Brake) indicator (red)" on the instrument pack illuminates, the parking brake is applied successfully.
- 4 Move the shift lever in 1st gear (flat ground or uphill) or R gear (downhill) when parking.
- 5 When the vehicle is on a slope, please turn the steering wheel to ensure that the vehicle is aimed at the curb when it slips.

Start-off

Manual release of EPB

- 1 The ignition switch is in "ACC/ON" position.
- 2 Depress the brake pedal.
- 3 Press the EPB switch (Ⓢ) to release the parking brake. When the "EPB (Electronic Parking Brake) indicator (red)" on the instrument pack goes out, the parking brake is released.

Automatic release of EPB

⚠ If a gear is engaged when the vehicle is stopped and the engine is running, never depress the accelerator pedal. Otherwise, the vehicle will immediately move on its own and an accident may occur.

- 1 The ignition switch is turned on.
- 2 The driver wears the seat belt.
- 3 The transmission is in any gear.
- 4 Depress the accelerator pedal. When starting off on a level ground or a slope, depress the accelerator pedal. When the traction is greater than the sliding force, the parking brake will automatically release, the "EPB (Electronic Parking Brake) indicator (red)" on the instrument pack will go out, and the vehicle starts to move.

Starting and Driving

Emergency Braking Function

Pulling up and holding the EPB switch (Ⓢ) will activate the emergency braking function. At this time, the vehicle will activate the hydraulic brake system to brake the four wheels, and its braking effect is like depressing the brake pedal firmly. The emergency brake will be released as long as the EPB switch is released or the accelerator pedal is depressed firmly.

Caution

This function is used when the normal braking operation has been failed.

Automatic EPB pull-up function

EPB (Electronic Parking Brake) has flameout power-off automatic pull-up function. You can select to enable the EPB power-off automatic pull-up function on the central control screen by the switch titled "Flameout Automatic Electronic Handbrake Pull-up".

This function is enabled by default, that is, EPB will be automatically pulled up when the vehicle is powered off in flameout state. If you select to disable this function, it will take effect only in current ignition cycle. In next ignition cycle, this function will automatically restore as enabled.

AUTO HOLD

Note: This applies to vehicles with AUTO HOLD.

The AUTO HOLD switch (Ⓐ) is located on the steering wheel side of the instrument panel, which is used to turn on or off the Auto Hold system.

The AUTO HOLD system supports the driver to reduce driving fatigue when the vehicle often encounters traffic lights or stops and goes repeatedly. The AUTO HOLD function enables the parking brake to release automatically when starting off, and the vehicle to park automatically when it is stationary.

AUTO HOLD ON

Caution

The following conditions should be met to turn on the AUTO HOLD function: the driver door is closed; the driver seat belt is fastened; the vehicle is started.

When pressing the AUTO HOLD switch (Ⓐ), the "AUTO HOLD

indicator (white)"  on the instrument pack will illuminate. When the vehicle is stationary and the "AUTO HOLD indicator (green)" on the instrument pack illuminates, the AUTO HOLD is operating and the driver can release the brake pedal. When the AUTO HOLD is operating, the ESP pressure hold parking will be performed first, and the ESP requests the EPB to apply parking brake if the vehicle is still stationary after 10 minutes.

Starting and Driving

The "AUTO HOLD Indicator (green)" goes out and the "EPB

(Electronic Parking Brake) indicator (red)"  illuminates.

During operation of the AUTO HOLD, opening the door or unfastening the seat belt will activate the EPB. The "AUTO HOLD indicator (green)" goes out and the "EPB (Electronic Parking Brake) indicator (red)" illuminates.

If you engage a gear and depress the accelerator pedal as usual, the parking brake will automatically release and the vehicle will start. The "AUTO HOLD indicator (white)" on the instrument pack remains on, and the AUTO HOLD is in standby state.

AUTO HOLD OFF

When pressing the AUTO HOLD switch , the "AUTO HOLD indicator (white)" on the instrument pack will go out, and the AUTO HOLD function will be off.

 **Do not perform auto hold on the road with a slope greater than 25%, otherwise the vehicle may slip.**

When the "AUTO HOLD indicator (yellow)"  on the instrument pack illuminates and the AUTO HOLD system fails, please drive immediately to our Service Dealer for vehicle inspection.

Warning light

Warning lamps related to brake system include "brake system warning light (red)", "ABS warning light (yellow)", "EBD warning light (red)", "ESP indicator (yellow)", "ESP OFF indicator (yellow)", "EPB (Electronic Parking Brake) indicator (red)", "EPB (Electronic Parking Brake) malfunction indicator (yellow)" and "AUTO HOLD indicator", please see "Warning lights and indicators" in Before You Drive section.

Starting and Driving

Cruise control system

 Cruise control can be dangerous where you can not drive safely at a steady speed. Therefore, do not use the cruise control on winding roads or in heavy traffic. It is also dangerous to use the cruise control system while driving on a slippery road. On such roads, fast changes in tire traction can cause excessive wheel spin, and you could lose control. **Do not use the cruise control on a slippery road.**

Your vehicle may be equipped with the cruise control system. With the cruise control, you can maintain the vehicle speed at 40km/h or above without keeping depressing the accelerator pedal. The cruise control system does not work when the vehicle speed is less than 40 km/h.

For vehicles with the traction control system or electronic stability control system, the system starts to limit wheel spinning when the cruise control system is working. In case of this situation, the cruise control will be automatically disabled.

When the vehicle starts the cruise control system, if it encounters a continuous climbing condition, it may cause the current driving speed of vehicle to be less than the set cruise control speed.

Cruise control settings

Setting cruise control

 If the cruise control stays on when you do not use it, you may touch the button and accidentally enter the cruise state. Then you may get scared and lose control of the vehicle. Therefore, keep the cruise control switch "Off" until you need to use the cruise function.

The cruise control switch is located on the steering wheel.

 : Cruise On/Off switch. Press this button to turn on/off the cruise control system. The "cruise control indicator" in the instrument cluster illuminates or goes out accordingly.

 : Cruise cancel switch. Press this button to cancel the cruise function without clearing the set speed in the memory.

RES+ : Cruise recovery/acceleration switch. If a set speed has been stored, press RES+ to resume that speed; press RES+ again to accelerate (1km/h per time).

SET- : Cruise setting/deceleration switch. Press SET- to set a speed. Then the cruise function will be enabled and the "cruise control indicator lamp" on the instrument cluster will turn green from white. If the cruise function is operating, press SET- to decelerate (1km/h per time).

Starting and Driving

Setting speed

- 1 Press  to turn on the cruise control system. Meanwhile the "cruise indicator lamp (white)" in the instrument cluster will illuminate.
- 2 Accelerate to the desired speed.

Note: *This speed must be higher than 40km/h.*

- 3 Press SET- and then release it. Then the current speed will be stored and maintained. The speed set will appear in the instrument cluster display momentarily, and the "cruise indicator lamp" on the instrument cluster will turn green from white.
- 4 Release the accelerator pedal, and then the vehicle will cruise at a steady speed. The cruise control function will be disabled when the brake is enabled.

Resume the set speed

If you have set the cruise speed of cruise control system, the cruise control function will be disabled when you depress the brake pedal or press , but this set speed in the memory will not be cleared. To resume the pre-set speed, press RES+ when the vehicle speed reaches 40km/h or above, and then the vehicle speed will recover to the pre-set value.

Accelerating with cruise control enabled

There are two methods to accelerate:

- Accelerate by depressing the accelerator pedal.

- If the cruise control system has been enabled, press RES+, and hold it until the vehicle accelerates to the desired speed, and then release it. To accelerate by minor increment, short press RES+, and then release it. Each time this is done, the vehicle goes about 1.0 km/h faster.

Decelerating with cruise control enabled

If the cruise control system has been enabled:

- Press SET-, and hold it until the vehicle decelerates to the desired speed, and then release it.
- To decelerate by minor increment, short press SET-, and then release it. Each time this is done, the vehicle goes about 1.0 km/h slower.

Overtaking with cruise control enabled

Speed up with the accelerator pedal. When you release the accelerator pedal, the vehicle will decelerate to the pre-set cruise control speed.



Using cruise control on slopes

The performance of cruise control system on a slope depends on the speed, load as well as the gradient of the slope. When the vehicle runs uphill, it may be required to depress the accelerator pedal to maintain the vehicle speed. When the vehicle runs downhill, it may be required to brake or shift to a low gear to maintain the vehicle speed. The cruise control function will be disabled when the brake is enabled.

Starting and Driving

Terminating cruise control

There are three ways to disable the cruise control:

- Slightly depress the brake pedal once; the "cruise control indicator lamp" in the instrument cluster will turn white from green when the cruise control is disabled.
- Press .
- Press  to turn off the cruise control system completely. The cruise control speed will not be resumed.

Clearing speed memory

The cruise control set speed memory will be cleared when you press  or turn off the ignition switch.

Parking assist system

Note: *The type of parking assist system equipped on your vehicle is subject to the actual vehicle configuration purchased.*

Parking sensor

 **The parking assist system is not always reliable and is only playing the role of guidance! The parking sensors might not detect some types of obstacles, including slim objects (such as wire nets and ropes), small objects close to the ground, conic objects and some objects with non-reflective surfaces.**

The parking sensors shall be free of dirt, ice, and snow. The sediment on surfaces of parking sensors will impair the normal functioning of the sensors. Therefore, avoid directly flushing the parking sensors from a short distance by a high pressure water gun while washing your vehicle.

Four parking sensors installed on the rear bumper are functioned to scan the rearward area of vehicle, in order to judge the presence of obstacles. Upon detection of any obstacle, the parking sensors will calculate its spacing from the rear of the vehicle and send the information to the driver by alerting tones. It's really important that this system is only a parking assist system and can't function as the replacement for your observation and personal judgment.

Starting and Driving

Working status of parking sensor assist system

After shifting into the reverse gear, the parking assist system will start automatically. When selecting other gears, the parking assist system will stop working.

Note: If the system gives out a prompt tone of 3s after the gear is shifted to "R", it indicates that the system has a malfunction. Contact Our Service Dealer for service as soon as possible.

Parking process

When the vehicle is at about 150cm distance from the rear barrier, the system will start making alarm sounds. And the alarm sound become harsher when the vehicle is approaching the barrier.

When the distance of the vehicle from the rear barrier is less than 30 cm, the system will produce a long alarm sound. At this moment, it is impossible to effectively identify the barrier if you continue to reverse the vehicle.

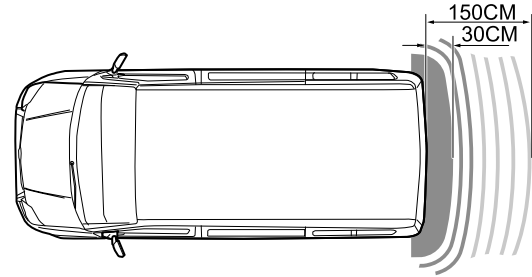

Starting and Driving

Front and rear sensors



The parking assist system is not always reliable and is only playing the role of guidance! The sensors might not detect some types of obstacles, including slim objects (such as wire nets and ropes), small objects close to the ground, conic objects, and some objects with non-reflective surfaces.

The sensors shall be free of dirt, ice, and snow. The sediment on surfaces of sensors will impair the normal functioning of the sensors. Therefore, avoid directly flushing the sensors from a short distance by a high pressure water gun while washing your vehicle.

The sensors located in the front bumper will scan the front area of the vehicle, and the sensors located in the rear bumper will scan the rear area of the vehicle to determine whether there is any obstacle. Upon detection of any obstacle, the parking sensors will calculate its spacing with the vehicle and send the information to the driver by alerting tones. It's really important that this system is only a parking assist system and can't function as the replacement for your observation and personal judgment.

Working status of parking assist system with front and rear sensors

Rear parking assist system

After R gear is selected, the rear parking assist system will automatically turn on. Shift out of the R gear and the rear parking assist system will automatically stand by.

Front parking assist system

When the ignition switch is in "ON" position, the front parking assist system will automatically turn on. When it is shifted to D gear, R gear or N gear and the parking brake is released, and when the vehicle speed is less than 15km/h and the front radar alarm tone switch is turned on, the front parking assist system will enable the detection function.

Note: When the ignition switch is in "ON" position, if the display screen gives out a 3-second prompt tone, it indicates that the parking sensor assist system has failed and Our Service Dealer shall be contacted for overhaul as soon as possible.

Front radar alarm tone switch

The front radar alarm tone switch is located on the entertainment system screen. You can turn this function on or off through the settings on the entertainment system screen.

Each time the vehicle ignition is turned on again, the front radar warning tone switch is turned on by default. You can turn this

Starting and Driving

function on or off through the settings on the entertainment system screen according to driving needs.

Parking process

When the two middle radars in the rear of the vehicle are about 150cm away from the barrier, or when the radars on both sides are about 60cm away from the barrier, the parking assist system starts to make alarm sounds. And the alarm sound become harsher when the vehicle is approaching the barrier.

When the two middle radars in the front of the vehicle are about 120cm away from the barrier, or when the radars on both sides are about 60cm away from the barrier, the parking assist system starts make alarm sounds. And the alarm sound become harsher when the vehicle is approaching the barrier.

When the distance of the vehicle from the front or rear barrier is less than 30cm, the parking assist system will sound a long alarm. At this moment, it is impossible to effectively identify the barrier if you continue to reverse the vehicle.

Note: When the front parking assist system works under D gear and N gear, the front radar will detect obstacles under normal working conditions and will produce alarm sounds. If the distance from obstacles does not change after 5 seconds, the system will stop sending alarm frequency signals. If the distance from obstacles changes again, the front parking assist system will resume sending alarms.

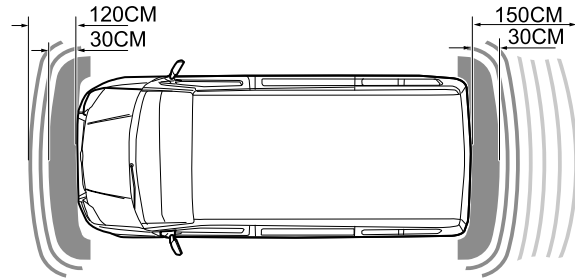

Starting and Driving

Parking camera

! The parking camera assist system is not always reliable and is only playing the role of guidance! Due to limited visual field, the parking camera can't detect any obstacle beyond its visual field.

Working status of parking camera assist system:

After selecting R gear, the entertainment system screen will be switched to the operation condition of parking cameras, displaying the scene behind the vehicle as reverse reference.

When selecting other gears, the parking camera assist system stops working and the display returns to the original state.

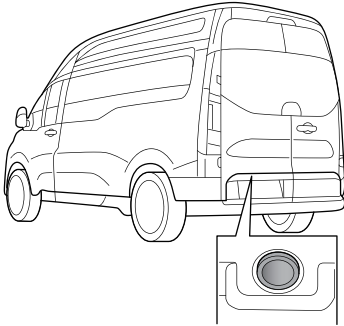

Note: When the vehicle enters the reversing state, cameras will output static reversing tracks which are displayed on

the entertainment system screen, take the horizontal plane as reference, and identify the area behind the vehicle in segments divided by red, yellow and green lines. Adjusting the screen brightness of the entertainment system display screen will synchronously affect the reverse image interface.

Caution

When a camera malfunction icon  appears on the reverse interface, you should contact Our Service Dealer for repair as soon as possible.

360° around-view system



360° around-view system is not always reliable. It only plays the role of assistance! Due to limited visual field, the camera can't detect any obstacle beyond the blind spot and its visual field; even when the system is running, be also careful to view the environment around the vehicle.

360° around-view system includes four cameras and one controller, and the cameras are respectively located in four orientations of front, rear, left and right.

Function on

- Select the reverse gear to trigger the around-view system.
- When the vehicle speed is lower than 30km/h, wake up the panoramic system through "360" icon on the main interface of entertainment system screen.

After the function is turned on, 2D front/rear/left/right viewing angles can be switched in the operation area.

Function off

- When the vehicle is not in R gear, click "X" at the top left corner of the screen under the panoramic interface to turn it off.

Function settings

Click the "Settings" on the screen under the panoramic interface, and users can choose to turn on/off the sub-functions such as

"Steering trigger panorama", "Forward track line" and "Wide viewing angle".

Note: Adjusting the screen brightness of the entertainment system display screen will synchronously affect the reverse image interface.

Caution

When a camera malfunction icon  appears on the 360 interface, you should contact Our Service Dealer for repair as soon as possible.

Starting and Driving

Driver assistance system

Note: *The type of advanced driver assistance system on your vehicle depends on the actual vehicle configuration you purchased.*

Camera

Front-view camera is installed inside the front windshield at the interior rear-view mirror. Front-view camera provides target acquisition for the driver assistance system.

Caution

If the camera sensor hardware is damaged, it must be repaired or replaced. It is recommended to drive the vehicle to our service dealer for repair, and never replace it by yourself.

It is not allowed to install license plate frame or other objects on the front/rear license plate board to prevent interference with camera or radar sensor; regular maintenance is required for the license plate to avoid deformation from affecting the radar sensor performance.

Not all traffic environment, weather and driving conditions are suitable for the camera to function properly, therefore, in a complex environment or bad weather, please drive carefully.

Camera maintenance

In order to keep the proper operation of camera, please ensure there is no foreign matter such as dust, ice and snow, and water on the front of camera.

When there is a foreign matter in front of the radar, please clean it with soft cloth. Never use water cannon, or damage the lens of camera.

The replaced assembly structure of camera must be our original part. After part replacement, the camera must be re-calibrated at our service dealer, so as to ensure that all vehicle systems based on the camera function properly.

Service restrictions

When the camera cannot work properly, the function that provides detection information based on the camera is restricted or abnormal.

The camera has limited detection range and capability, so that it cannot detect the target out of its detection range.

The performance of camera will be restrained in the following environment:

- The camera's view is blocked, and the surface is covered with foreign matters, such as dust, ice and snow, water, etc.
- Weather conditions with poor light or low visibility.
- Over exposure of camera due to direct sunlight.
- Dramatic light change (e.g in/out tunnel).
- Camera jolt due to bumpy road or other factors.

Radar

Millimeter wave radar is installed inside the front grille or inside the rear bumper. Millimeter wave radar provides target acquisition for the driver assistance system.

Caution

In order to avoid affecting the detection performance of radar sensor, it is strictly prohibited to paint or modify the body and front/rear bumper without permission.

If the radar sensor hardware is damaged, it must be repaired or replaced. It is recommended to drive the vehicle to our service dealer for repair, and never replace it by yourself.

It is not allowed to install license plate frame or other objects on the front/rear license plate board to prevent interference with camera or radar sensor; regular maintenance is required for the license plate to avoid deformation from affecting the radar sensor performance.

Not all traffic environment, weather and driving conditions are suitable for the radar sensor to function properly, therefore, in a complex environment or bad weather, please drive carefully.

Radar maintenance

In order to keep the proper operation of radar, please ensure there is no foreign matter such as dust, ice and snow, and water on the front of radar.

When there is a foreign matter in front of the radar, please clean it with soft cloth. Never use water cannon, or damage the front surface of radar.

The replaced assembly structure of radar sensor must be our original part. After part replacement, the radar sensor must be re-calibrated at our service dealer, so as to ensure that all vehicle systems based on the radar sensor function properly.

Service restrictions

When the radar cannot work properly, the function that provides detection information based on the radar is restricted or abnormal.

The radar has limited detection range and capability, so that it cannot detect the target out of its detection range.

The performance of radar will be restrained in the following environment:

- The radar's surface is covered with foreign matters, such as dust, ice and snow, water, etc.
- The objects detected by radar may have wave-absorbing interference substance, such as cotton object, etc.
- Bad weather conditions, such as heavy rain, snow, fog, etc.
- Radar jolt due to bumpy road or other factors.

Starting and Driving

FCW and AEB (Forward collision assist)

Forward collision assist includes FCW (Forward Collision Warning) and AEB (Automatic Emergency Braking). The FCW function warns the driver of pedestrians, bicycles or vehicles in front of the vehicle with visual and audio signals. If the driver fails to take actions within a reasonable period of time, the system will trigger the AEB function.

Collision assist function may enable urgent and instantaneous braking to cope with different collision risks. These may make the driver feel uncomfortable, in this case, the driver shall perform active braking.

If the collision risks increase further, the system will brake dramatically and stop the vehicle in normal conditions. For most drivers, this is not a normal driving style and they may feel uncomfortable. After the collision assist function successfully avoids collision with the vehicle ahead, the vehicle will remain stationary for a while, at which moment the driver shall take actions as soon as possible.

Generally, the collision assist function will not be perceivable to the driver or passengers until the vehicle is about to collide. The collision assist function will be enabled when the driver should start braking in advance, but it cannot help the driver in all conditions.

Function on or off

Function on mode

When the vehicle is started, the collision assist function is on by default.

If you turn the function off and want to turn on it again, set in the entertainment system screen: Settings->Advanced Driver Assistance->Collision Assist On.

When the function is activated, the "FCW (Forward Collision Warning)/AEB (Automatic Emergency Braking) warning light

(yellow)"  on the instrument cluster goes out.

Function off mode

Set in the entertainment system screen: Settings->Advanced Driver Assistance->Collision Assist Off.

When the function is off, the FCW and AEB functions will be disabled at the same time, and "FCW warning light/AEB warning



light (yellow)"  on the instrument cluster is always on.

Sensitivity control

Set in the entertainment system screen, and click "...” or ">" on the right of Collision Assist, the options "Low", "Standard" and "High" will pop up; you may select applicable sensitivity according to your needs.

Starting and Driving

Information prompt

- Visual alarm
 - Indicator prompt: During the forward collision warning, the "FCW (Forward Collision Warning)/AEB (Automatic Emergency Braking) warning light (yellow)"  flashes; during the automatic emergency braking, the "FCW (Forward Collision Warning)/AEB (Automatic Emergency Braking) warning light (red)"  flashes.
 - Text reminder: Risk of collision/automatic emergency braking.
- Audible alarm: The entertainment system speaker alarms.

Caution

The collision assist is an auxiliary function that cannot work under all driving, traffic, weather and road conditions, which cannot replace the driving and accurate judgment. The performance of the system may be degraded by other factors, so that the driver should drive carefully and do not rely solely on the system. Before using the collision assist, the driver should check the restrictions they need to know by referring to this section.

Caution

The collision assist is designed to decrease the vehicle speed as much as possible to reduce the losses caused by collisions, instead of complete prevention of collisions. The driver should drive carefully and do not rely on the system.

When the system gives visual and audible warnings, the driver should immediately take further measures to avoid risk of collision and do not rely solely on the system.

The recognition range of front view camera and front millimeter wave radar realized by collision assist is limited, so you should not rely solely on the system to prevent collisions.

Due to the inherent limitations, the system may give a warning or brake when there is no risk of collision. The driver should always pay attention to the traffic environment ahead and take appropriate measures immediately.

The operating range of the collision assist system is 8km/h to 130km/h.

With the collision assist activated, if the "FCW (Forward Collision Warning)/AEB (Automatic Emergency Braking)

warning light (yellow)"  is always on, please go to our service dealer for repair.

Starting and Driving

Service restrictions

- When the vehicle speed is lower than 8km/h, the system will not give alarm. The system triggered occasionally due to low vehicle speed in congestion road may provide poor driving experience.
- The driver shall ensure the seat belt is fastened property, otherwise the AEM will not function.
- Please ensure the ESP (Electronic Stability Program) and collision assist function are on, otherwise the collision assist function will not function.
- Certain targets, such as highway barriers, tunnel entrances, heavy rain or ice, can affect or impair sensor detection, thus affecting AEB functions.
- The precondition for collision assist function to respond to the relevant target is that the target must be in the field of view of the sensor and be recognized. The collision assist function will be significantly limited with respect to cutting-in targets, those not detected until the current vehicle changes lane and those in the sharp turn road.
- The system will not respond to animals.
- Severe weather, such as wind, heavy rain, fog, etc., will affect the detection capability of the camera, which will reduce the system performance or increase the false trigger rate.
- For camera restrictions, see “Camera”.
- For radar restrictions, see “Radar”.

LDW (Lane Departure Warning)

LDW function provides assist for driver on expressway, fast roads and similar arterial roads. When the driver unintentionally departs from current lane, it will warn and prompt the driver to return to the original lane, avoiding the resulting traffic accident.

The LDW function will be enabled when the vehicle speed is higher than or equal to 60km/h and the road markings are visible. The system will not send alarm messages when the driver drives at low speed or takes active driving (judged by turning on direction indicator/changing lane in emergency).

Function on or off

Function on mode

Set in the entertainment system screen: Settings->Advanced Driver Assistance->LKA On.

Function off mode

Set in the entertainment system screen: Settings->Advanced Driver Assistance->LKA Off.

When the function is deactivated, the "LDW (Lane Departure Warning)/LKA (Lane Keeping Assist)/ELK (Emergency Lane

Keeping) warning light (yellow)"



is always on.

Starting and Driving

Audible alarm

Set in the entertainment system screen, and click “...” button on the right of LDW, the options “ON” and “OFF” will pop up. The audible alarm function can be turned on or off.

Sensitivity control

Set in the entertainment system screen, and click “...” or “>” on the right of LDW, the options “Low”, “Standard” and “High” will pop up; you may select applicable sensitivity according to your needs.

Information prompt

When the driver unintentionally departs from current lane, the system will remind the driver through the warning icon on the instrument cluster together with buzzer sound, and corresponding lane line on the instrument cluster is displayed in red. It means the vehicle is at the risk of lane departure, and the driver shall correct the vehicle to original lane in time.

Caution

LDW is only a driving function for alarm assistance.

The driver shall never fully rely on the LDW function to reminder of lane departure, but shall bear the responsibility of safe driving. LDW cannot function under all driving conditions or traffic, weather and road conditions.

When the lane keeping assist system fails, i.e. after the lane keeping assist function is activated, the "LDW (Lane Departure Warning)/LKA (Lane Keeping Assist)/ELK

(Emergency Lane Keeping) warning light (yellow)"  is always on, please go to our service dealer for repair.

Service restrictions

LDW cannot clearly detect the lane lines all the time. You may receive useless or invalid warning in the following conditions:

- Road construction areas, sharp turn or narrow roads.
- Dark (poor lighting) or weather conditions (due to heavy rain, snow, fog and wind). The recognition capability of the camera is deteriorated under direct sunlight or oncoming strong light.
- The camera's view is blocked by the large vehicle ahead or vehicle running nearby. The windshield in the camera's view is blocked (by water mist, dust or paster, etc.).
- The width and quality of lane lines are unsatisfactory, for example, the lane lines are worn and blocked, the new and old lane lines coexist, or change of lane lines in construction

Starting and Driving

sections. A large area of shadows are formed by the projection of trees, large objects or landscape features on the lane.

- LDW may miss warning or send incorrect warning in the following conditions:
 - For camera restrictions, see “Camera”.
 - Weather conditions (heavy rain, snow, fog, extreme hot or cold temperature) interferes with camera operation.

The warnings and restrictions above do not cover all situations that may interfere with LDW. There are many factors that may disable LDW function. To avoid departure from the current lane, the driver shall keep alert, and pay close attention to the road conditions, so as to take corrective measures as early as possible.

LKA (Lane Keeping Assist)

When activated, LKA function will determine the position of vehicle relative to the lane lines based on the road boundary information acquired by the camera, and in combination of the vehicle state and the driver input, alarm the driver or return to the vehicle to the original lane by intervening the turning if the driver unintentionally departs from the lane. The function is a safety function, which corrects the vehicle when the vehicle is about to depart from the lane. It is not a comfort function of lane centering, etc., so the driver shall hold the steering wheel at the time.

The LKA function will be enabled when the vehicle speed is at 60km/h - 120km/h and the road markings are visible. The system will not send alarm messages or automatically intervene the turning when the driver drives at low speed or takes active driving (judged by turning on direction indicator/changing lane in emergency).

Function on or off

The button for the LKA to be on or off is the same one as for LDW. See “LDW (Lane Departure Warning)” in this section for the operation mode.

Information prompt

When the driver unintentionally departs from current lane, the system will remind the driver through the warning icon on

Starting and Driving

the instrument cluster together with buzzer sound, and may intervene the turning to return the vehicle to the original lane.

Caution

LDW is only a driver assistance function. The driver shall never fully rely on the LKA function to prevent the vehicle from departure of the current lane, but shall bear the responsibility of safe driving.

The driver shall observe traffic rules, and hold the steering wheel with both hands. If the driver has not held the steering wheel, the system will not provide the LKA function.

The LKA will not always help the driver correct the vehicle about to depart, and the driver must takeover the vehicle after LKA correction to ensure stable driving.

LKA cannot function under all driving conditions or traffic, weather and road conditions.

When the lane keeping assist system fails, i.e. after the lane keeping assist function is activated, the "LDW (Lane Departure Warning)/LKA (Lane Keeping Assist)/ELK



(Emergency Lane Keeping) warning light (yellow)" is always on, please go to our service dealer for repair.

If the vehicle suspension suite after replacement has not approved by us, the LKA system may operate improperly.

Service restrictions

LKA cannot clearly detect the lane lines all the time. You may receive invalid warning or false interference in the following conditions:

- Road construction areas, sharp turn or narrow roads.
- Dark (poor lighting) or weather conditions (due to heavy rain, snow, fog and wind). The recognition capability of the camera is deteriorated under direct sunlight or oncoming strong light.
- The camera's view is blocked by the large vehicle ahead or vehicle running nearby. The windshield in the camera's view is blocked (by water mist, dust or paster, etc.).
- The width and quality of lane lines are unsatisfactory, for example, the lane lines are worn and blocked, the new and old lane lines coexist, or change of lane lines in construction sections. A large area of shadows are formed by the projection of trees, large objects or landscape features on the lane.
- LKA may miss warning or send incorrect warning in the following conditions:
 - For camera restrictions, see "Camera".
 - Weather conditions (heavy rain, snow, fog, extreme hot or cold temperature) interferes with camera operation.

The warnings and restrictions above do not cover all situations that may interfere with LKA. There are many factors that may disable LKA function. To avoid departure from the current lane, the driver shall keep alert, and pay close attention to the road conditions, so as to take corrective measures as early as possible.

Starting and Driving

ELK (Emergency Lane Keeping)

When the ELK (Emergency Lane Keeping) function is activated, it determines the position of the vehicle relative to the adjacent vehicle or curb, etc. based on the road environment information obtained by the front cameras and corner millimeter wave radars, and will warn the driver or keep the vehicle away from the risk of collision by steering intervention in combination with the vehicle status and driver input if the driver departs unintentionally, causing risk of collision with the adjacent vehicle or curb, etc. This is a safety function, not a comfort function.

The lane keeping function is activated when the vehicle speed is between 60km/h and 120km/h and the road markings are clearly visible.

When the vehicle is driven at low speed or actively (judged by rapid lane change, etc.), the system will not give an alarm or automatically intervenes in steering.

Function on or off

The button for the ELK to be on or off is the same one as for LDW. See "LDW (Lane Departure Warning)" in this section for the operation mode.

Information prompts

When the driver departs unintentionally and there is a risk of collision with the adjacent vehicle or curb, etc., the system will remind the driver through the warning icon on the instrument cluster and the sound of the buzzer, and may intervene in

steering to keep the vehicle away from the adjacent vehicle or curb, etc. to avoid the risk of collision.

Caution

The emergency lane keeping assist is just a driver assistance function. The driver should not rely solely on the emergency lane keeping function to prevent collision with the adjacent vehicle or curb, and should bear the responsibility for safe driving.

The driver should follow the traffic regulations and hold the steering wheel firmly with both hands. If the driver does not hold the steering wheel, the system will not provide the emergency keeping assist function.

The emergency lane keeping assist will not always help the driver correct the vehicle with a tendency to collide with the adjacent vehicle or curb, and the driver must take over the vehicle after correction to ensure that the vehicle is stable.

The emergency lane keeping assist cannot work under all driving or traffic, weather and road conditions.

When the emergency lane keeping assist system fails, i.e. after the lane keeping assist function is activated, the "LDW (Lane Departure Warning)/LKA (Lane Keeping Assist)/ELK

(Emergency Lane Keeping) warning light (yellow)"  remains on, please drive to Our Service Dealer for service.

Starting and Driving

Caution

If the vehicle suspension kit replaced by yourself is not approved by us, the emergency lane keeping assist system may not operate properly.

Usage restrictions

The emergency lane keeping assist cannot clearly detect lane lines at all times. You may receive invalid warning or false interference under the following conditions.

- In road construction areas, at sharp turns or on narrow roads.
- Darkness (poor lighting) or weather conditions (due to heavy rain, heavy snow, dense fog or high wind).
- The recognition capability of the camera is deteriorated under direct sunlight or oncoming strong light.
- The lateral vehicle is large or the vehicle appearance is irregular, and the curb is severely damaged or unconventional, so that the cameras cannot accurately identify it as the object to be avoided.
- Camera view blocked (water mist, dust, or sticker, etc.).
- The width and quality of lane lines fail to meet the requirements, such as lane lines worn or covered, presence of both old and new lane lines, or lane lines changed by construction sections.
- Large shadows are projected on the lane by trees, large objects, or landscape features, etc.
- The emergency lane keeping assist may miss a warning or give a false warning under the following conditions:

- See "Camera" for camera restrictions.
- Weather conditions (heavy rain, snow, fog, extremely high or low temperatures) interfere with camera operation.

The above warnings and restrictions do not include all conditions that may interfere with emergency lane keeping assist. Many factors may cause the emergency lane keeping assist to be inoperative. In order to avoid the risk of collision with the adjacent vehicle or curb, the driver should remain vigilant and always pay attention to the road conditions, so that corrective measures are taken as soon as possible.

2

Starting and Driving

SLIF (Speed Limit Information Function)

SLIF recognizes speed signs via intelligent front-view camera and sends relevant information to the instrument cluster, aiming to remind the driver the speed limit of current road to prevent overspeed. The system will not actively adjust the vehicle speed, which shall be controlled actively by the driver.

Function on or off

Set in the entertainment system screen: Settings->Advanced Driver Assistance->Speed Limit Assist, and select: SLIF On/Off.

Function on conditions

- The vehicle speed is lower than or equals to 130km/h.
- The sensor signal is normal (camera).
- Speed limit sign is detected.
- The front-view camera module at the front windshield is not blocked/fogged.

Note: When enabled, the function will not work temporarily when the vehicle speed is higher than 130km/h.

Information prompt

When the function is enabled, if the current vehicle speed is lower than that of the speed limit sign, the instrument cluster will display the current speed limit value.

When the current vehicle speed is detected to be greater than that of the speed limit sign, the traffic sign will flash with an audible alarm.



: It indicates the speed limit value of current road.

Caution

When the system cannot recognize the speed limit sign ahead, the instrument cluster will not display the speed limit sign information. The system only prompts the speed limit information, but will not control the vehicle speed.

The recognition of speed limit signs by the system is not completely accurate, but recognition error occurs, so that the driver shall drive cautiously based on actual road conditions.

Service restrictions

SLIF can only function properly when the speed signs are clear and visible. It may be unable to work or function under some situations: For example:

- Poor conditions of speed limit sign: such as fading, on the curve, improper placement angle, rotated or damaged, blocked fully or partly, too far away or too high, attached on the road surface.
- Driving so close to the vehicle ahead that the detection range of the camera is obstructed.
- Change to the road or speed limit recently, such as construction, regulation, etc.
- Some LED speed limit signs.
- For camera restrictions, please refer to “Camera”.

IHC (Intelligent High beam Control)

IHC (Intelligent High beam Control) recognizes the traffic environment ahead through the front view camera, automatically controls the low and high beam switching, prevents dazzling to the vehicles ahead and oncoming vehicles, and improves the safety and comfort of the driver in the dark environment, especially at night.

Function enable/disable

Function enable method

Set it in the central control screen: Exterior lamps-> Lamp settings -> Turn on IHC switch.

Function disable method

The IHC can be turned off in two ways:

- Long press the lever switch of high beam headlamp and direction indicator lamp for more than 3 seconds towards the steering wheel.
- Set it in the central control screen: Exterior lamps-> Lamp settings -> Turn off IHC switch.

Activation conditions

- The speed is higher than 40km/h.
- The lamp control switch is positioned in AUTO position.
- The low beam headlamp  has illuminated.
- The front view camera module at the front windscreen is not blocked/fogged, etc.

Note: After activated, the function does not work temporarily when the speed is below 25km/h.

Message prompt

After the IHC function is enabled, its working state can be observed by the IHC indicator on the instrument cluster.



When the "IHC indicator (blue)"  illuminates, it indicates that the conditions to turn on the high beam headlamp are met, and the system will automatically turn on the high beam headlamp.



When the "IHC indicator (grey)"  illuminates, it indicates that the conditions to turn on the high beam headlamp are not met, and the system will automatically turn off the high beam headlamp.

Starting and Driving

Caution

The front view camera module is installed on the front windscreen. It should be noted that the camera's field of view cannot be blocked by objects, which will affect its function.

IHC function can not accurately perceive the surrounding environment, which may cause the incorrect adjustment of the high beam/low beam. Please observe the local traffic regulations and use the function in a reasonable manner.

IHC is only a comfort function, and the driver needs to drive cautiously when using the function.

Service restrictions

- IHC function may be limited to camera state and suppression conditions. If the front-view camera module is not properly calibrated, IHC performance will be reduced.
- IHC performance may be reduced due to limited field of vision caused by dust over, rain, snow, fog, ice, and other factors.
- IHC performance may be reduced due to the interference of ambient light source. IHC performance may be reduced by highly reflective objects in the perception range of front-view camera module during driving.
- When ABS or ESP function is activated, the high beam and low beam states cannot be switched.
- IHC may be degraded in adverse weather conditions, such as wind, heavy rain, dense fog, etc.
- For camera restrictions, see "Camera".

Blind spot assist

BSA includes two active safety assist functions: BSD (Blind Spot Detection) and LCA (Lane Change Assist). When the subsystem detects that a vehicle is approaching at a fast speed in the blind spot of the rear-view mirror or from a distance, the system will warn the driver by LED lights on the left and right rear-view mirrors.

Function on or off

Set in the entertainment system screen: Settings->Advanced Driver Assistance->Blind Spot Assist, and select: BSA On/Off.

If the switch is grayed out and cannot be operated, please drive to our service dealer for service.

Monitoring diagram

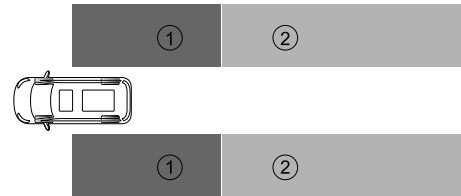

Area ① About 3m behind the blind spot of vehicle; Area ② About 70m behind the blind spot of vehicle.

Starting and Driving

Blind spot refers to the blind area in the field of vision behind the left and right rear-view mirrors of the vehicle (as shown in Figure ① below). If there is a vehicle in this area, this function provides the driver with favorable prompts to avoid the collision risk caused by turning or lane change.

In the area as shown in Figure ② below, there is a vehicle runs fast at a speed (greatly higher than your vehicle), and in this case, the function will provide the driver with favorable prompts to avoid the collision risk caused by turning or lane change.

Warning and prompt

When the vehicle is running at a speed above 15km/h, if it is in Area ① or Area ② where there is a rapidly approaching vehicle, the system will actively prompt the driver, and the corresponding side indicator will illuminate, as shown in the figure below.

If the driver intends to change lane or turn (by turning on the direction indicator on the side of the approaching vehicle), the indicator on the corresponding side will flash to warn the driver.

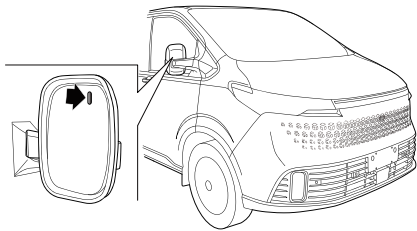

Caution

BSD and LCA will not provide warning assist in the event of an emergency turn.

BSA is a driver assistance function, which is unable to provide help in all conditions.

BSA is designed to work with left and right rear-view mirrors to provide better assistance, and cannot replace the rear observation of rear-view mirror.

If the indicator of exterior rear-view mirror is always on, please go to our service dealer for repair.

Service restrictions

- BSD cannot provide accurate alarm in all scenarios, and may produce unnecessary or miss warning due to many factors: such as large movable metals, complex metal walls, etc. in the blind spot formed by radar principle.
- The driver shall keep alert in driving, pay close attention to road conditions, and change lanes after making sure it is safe.
- For radar restrictions, see “Radar”.

Starting and Driving

RCTA (Rear Cross Traffic Alert)

The RCTA (Rear Cross Traffic Alert) is a driver assistance function, which warns the vehicles or pedestrians crossing on both left and right sides when the driver reverses the vehicle; the speed range of the rear cross traffic alert function is between 0 and 10km/h.

Function on or off

Set in the entertainment system screen: Settings->Advanced Driver Assistance->Blind Spot Assist, and select: BSA On/Off.

If the switch is grayed out and cannot be operated, please drive to our service dealer for service.

Monitoring diagram

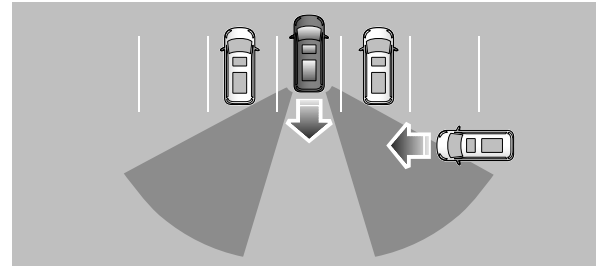
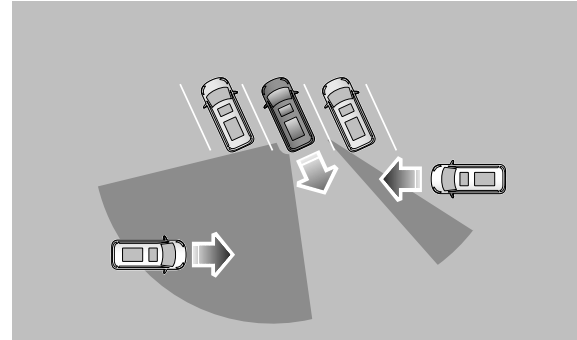
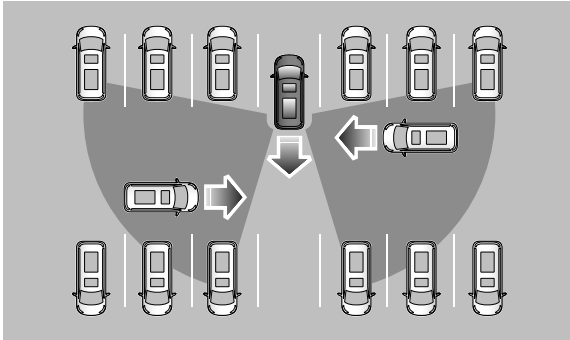

Warning and prompt

When the vehicle is in reverse mode (R gear), if there are vehicles and pedestrians moving transversely on both sides behind the vehicle, the indicator on the rear-view mirror on the corresponding side will flash to alarm and produce prompt tone to warn the driver.

Starting and Driving

Caution

RCTA cannot replace the rear observation of rear-view mirror.
RCTA is a driver assistance function, which is unable to provide help in all conditions.
RCTA does not mean the driver can relax, and it is the driver's responsibility to reverse in a safe manner.

Service restrictions

- RCTA cannot provide accurate alarm in all scenarios, and may produce unnecessary or miss warning due to many factors: such as large movable metals, complex metal walls, etc. in the blind spot formed by radar principle.
- The driver shall keep alert in reversing, pay close attention to road conditions, and reverse the vehicle after making sure it is safe.
- For radar restrictions, see "Radar".

DOW (Door Open Warning)

When the vehicle is stationary and not engaged in R gear, DOW function can detect vehicles, cyclists, pedestrians and other targets approaching the vehicle from the rear. If the driver or passenger's behavior of opening the door when an approaching target is detected, DOW will send a warning prompt to prevent the driver and passenger from scratching and bumping into the target when opening the door.

2

Function on or off

Set in the entertainment system screen: Settings->Advanced Driver Assistance->Blind Spot Assist, and select: BSA On/Off.

If the switch is grayed out and cannot be operated, please drive to our service dealer for service.

Monitoring diagram

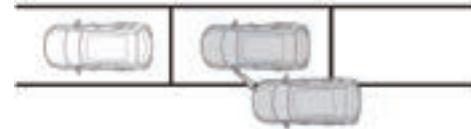

Warning and prompt

When a target approaches the stationary vehicle, DOW indicator will illuminate, and the driver or passenger shall avoid opening the door and confirm the safety of the opening environment first.

Starting and Driving

In this case, if the driver or passenger opens the door on the alarm side, the warning indicator will flash, there will be corresponding pop-up window and prompt tone on the instrument cluster and corresponding side door atmosphere light will illuminate to remind the driver or passenger to pay attention to the safety when opening the door.

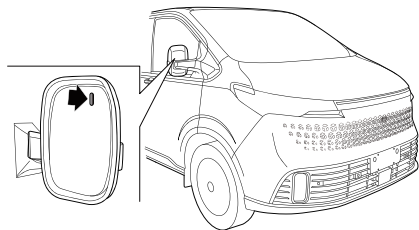

Caution

DOW is a driver assistance function, which is unable to work in all conditions or replace the rear observation of rear-view mirror.

DOW function is limited by the sensor principle and the complexity of the traffic environment, which may cause to send unnecessary or missed alarms. Therefore, the active observation of the door opening environment before getting off is the most effective measure for drivers and passengers to ensure personal safety.

Service restrictions

- DOW function is effective only when the vehicle is stationary and not in R gear, and it will not work when the vehicle is moving.
- The door opening warning function can be activated only when the vehicle is in a gear other than R and the vehicle speed is lower than 5km/h.
- This function can be activated only when the vehicle is stationary or its speed is lower than 3km/h; an alarm can be triggered only when the target vehicle speed is higher than 10km/h.
- DOW does not always work in all situations. Unnecessary or missed warnings may be produced for a variety of reasons, such as: small or stationary objects on the side or behind the vehicle; or other vehicles suddenly change lanes into adjacent detection areas.

The warnings and restrictions above do not cover all situations that may interfere with DOW. In order to avoid scratching when opening the door, drivers and passengers shall be sure to observe whether the door opening environment is safe and suitable.

Driver monitoring system

Note: *It is applicable to models with driver monitoring system.*

The driver monitoring system (DMS) monitors the driver fatigue and even more dangerous driving behaviors through the driver monitoring system camera, and gives corresponding effective prompts through vehicle system when these dangerous driving behaviors occur. The main detection functions of the DMS are as follows: obstruction detection, fatigue detection, distraction detection, and abnormal behavior detection.

Driver monitoring system camera

The driver monitoring system (DMS) uses an IR imaging camera located on the driver side, inside the A-pillar and facing towards the driver. A series of algorithms related to human face have been built into the entertainment system, which can detect and judge the driver's behavior during driving, synchronize the detected results with the entertainment system in time, and give a timely and effective prompt to the driver through the entertainment system. The camera does not record effective face information of the driver, but only detects different behaviors through the features of human face.

Driver monitoring system control switch

The DMS consists of a master switch and sub-switches, each sub-switch corresponds to a sub-function, and the master switch can control the state of all switches at the same time. The control

buttons of the entertainment system can be used to turn on or off the DMS.

- The master switch of the DMS is: used for driver state monitoring in the entertainment system.
- The sub-switches of the DMS respectively are: used for smoking behavior detection, phone use behavior detection, fatigue detection, and distraction detection in the entertainment system.

When each switch is switched from OFF to ON state, the corresponding function will take effect immediately; when each switch is switched from ON to OFF state, pop-up window will occur for second confirmation, and it takes effect after confirmation.

Driver monitoring system function

Obstruction detection

When the driver places an object in front of the camera, the monitoring function of the DMS camera will be affected, and in this case, the DMS will remind the driver that the DMS function will not execute properly, please remove the obstruction from the camera. Then the driver removes the obstruction from the camera to disable related alarm prompts. This function will work with the vehicle speed not less than 5km/h, and issue a pop-up window reminder on the instrument pack when it is triggered.

Starting and Driving

Fatigue detection

When the driver is fatigued to some extent, the DMS will estimate the fatigue degree of the driver through common fatigue behaviors such as yawning, eyes closing, etc., and conclude the fatigue degree of the driver through estimated results. If the fatigue degree exceeds a certain standard, the DMS camera will remind the driver through pop-up window and continuous alarm.

In addition, this function can also distinguish mild fatigue, moderate fatigue and severe fatigue. This function will work with the vehicle speed not less than 20km/h.

Distraction detection

When the driver gazes around during normal driving, the DMS camera will assess the overall focus direction of the driver according to the overall angle and time of head rotation of the driver, so as to judge whether the driver is distracted. It should be noted that, due to existence of time assessment, observing rearview mirrors and on-board mainframe for a short period of time will not trigger the distraction detection.

In addition, this function will be temporarily turned off to avoid misjudgment when it's required to call the body camera to project the scenarios to the on-board mainframe under circumstances like reversing.

This function will work with the vehicle speed not less than 20km/h, and issue a pop-up window reminder on the instrument pack when it is triggered. This function will not be activated

when the direction indicator lamps, reversing camera and 360 camera are working.

Abnormal behavior detection

When the driver is smoking or making a phone call, the DMS camera will judge whether the driver is currently doing an improper driving behavior such as smoking, making a phone call, etc. through detecting the objects in the driver's hands and the corresponding position of the objects. If corresponding behavior is detected, the system will issue a pop-up window reminder on the instrument pack, to try to avoid such improper driving behavior as much as possible, playing a corresponding correction function.

This function will work with the vehicle speed not less than 20km/h.

Tires



DEFECTIVE TIRES ARE DANGEROUS!

Do NOT drive your vehicle if any tire is excessively worn or damaged, or is inflated to an incorrect pressure.

Do NOT overload vehicle.

Incorrect tire inflation pressures or an unbalanced wheel and tire assembly can seriously affect the stability, especially when driving with high payloads or at high speeds. Under-inflation will increase rolling resistance, increase fuel consumption and accelerate tire wear, resulting in tire damage, even an accident.

Always drive with consideration for the condition of the tires; the most common causes of tire failure are:

- Bumping against kerbs.
- Driving over deep pot holes.
- Tire under-inflation or pressure overload during driving.

Uneven tread wear can be caused by faulty wheel alignment.

See “Tires” in Maintenance and Service section.

Winter tires



The vehicle speed shall not exceed the maximum allowable speed of the installed winter tires, otherwise the tires may suddenly lose pressure, delaminate, or even burst, which may easily cause accidents!

Be sure to adjust the speed according to the specific climate, roads and traffic conditions. Do not take risks by taking advantage of the anti-skid performance provided by winter tires and beware accidents!

Winter tires can improve the handling stability and braking performance of the vehicle when driving in a low temperature environment or on icy roads. It is suggested that winter tires should be used when the temperature is lower than 7°C.

When a vehicle is running under winter road conditions, winter tires can greatly improve the handling stability and braking performance. Non-winter tires have poor skid resistance at low temperatures or on icy roads due to their structure (tire width, rubber composition, pattern type, etc.).

It is recommended to use winter tires of the same size and load index as that of the original tires, and all the four wheels shall use winter tires.

When the tread depth of winter tires is worn to 4mm, the skid resistance will decrease obviously.

Starting and Driving

The maximum allowable speed of winter tires shall be subject to the speed code on the tires.

Speed symbol	Maximum speed (km/h)
C	60
D	65
E	70
F	80
G	90
J	100
K	110
L	120
M	130
N	140
P	150
Q	160
R	170
S	180
T	190
H	210
V	240
W	270
Y	300

When the temperature rises above 7°C, it is recommended to replace winter tires with non-winter tires.

Anti-skid chain

When driving a vehicle in the snow, it is recommended to apply S anti-skid chain to the driving wheels.

The anti-skid chain could increase the traction when driving on roads in winter. If you want to install the anti-skid chain, please remember that:

- 1 Not all wheels and tires are suitable for an anti-skid chain.
When installing anti-skid chains, only approved tire size can be used.
- 2 Install anti-skid chains on the drive wheels. Please follow the instructions of anti-skid chain manufacturer.

It is just in the snow that you can drive the vehicle at maximum speed allowed by the anti-skid chain. Please comply with the regulatory requirements of the resident country. Remove the anti-skid chain immediately when driving on the snow-free road.

Starting and Driving

Loading

Each driver is obliged to ensure his vehicle is free of overload.

Note: *The maximum allowable total mass is indicated on the VIN Plate located at front lower of B pillar. This Handbook introduces the correct vehicle weight parameters, see “Vehicle weight parameters” in General Technical Parameters section.*

Load carrying

Goods shall be placed between both axles and neither deviate to the front axle loading area nor the rear axle loading area. Heavier goods shall be distributed evenly, and the heaviest goods shall be placed between both axles.

Hazardous loads

There is a legal requirement to display a specific type of external warning sign on the vehicle if certain hazardous goods are being carried.

Load restraint

! **Secure all loads in the vehicle to prevent personal injury due to movement of loads.**

Note: *The driver is obliged to ensure all goods have been fixed correctly.*

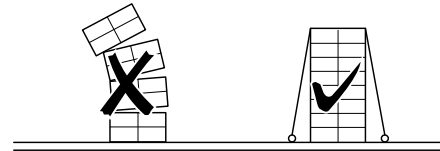

Load restraint assemblies

! **Load restraint assemblies, when installed, will stand out from the vehicle floor. To prevent people from tripping, it is recommended that they be removed when not needed.**

Holes of load restraint assemblies are pre-set on the van floor. Qualified load restraint assemblies can be purchased and installed from Our Service Dealer.

Starting and Driving

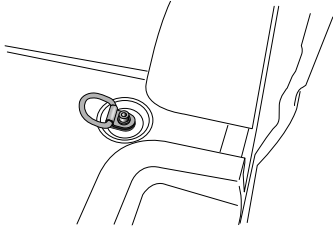

Partition

! As the full partition is not designed to restrain loads, loads shall be secured properly against movement even with a partition installed.

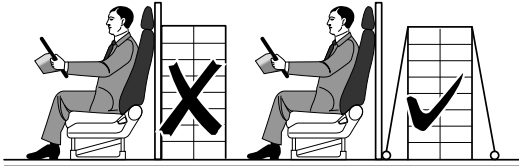

Trailer towing

Instructions of trailer towing

The vehicles are designed for use primarily as a passenger and load bearing vehicle. Towing a trailer may create adverse effects on a number of factors including fuel consumption, handling, durability, performance and braking. We recommend for the safety of yourself, your passengers and others that the vehicle and trailer is not overloaded.

The warranty does not cover any damages caused by or relating to towing a trailer.

- Weight limits

Establish that gross vehicle weight, trailer tow ball down load, trailer weight and axle weights are all in accordance and not exceeding their individual limits.

- Gross vehicle weight

Please refer to your vehicles data label for reference on what gross vehicle weight must not be exceeded.

Gross vehicle weight is the combined weight total of the trailer towbar, unloaded vehicle, driver, luggage and passengers. This also includes the weight of any accessories or equipment added to the vehicle.



Front end accessories such as bull bars, lights, winches etc. may restrict air flow to the vehicles cooling system. When the vehicle is under load, especially when towing, restricted air flow to the cooling system may decrease the efficiency of the radiator and intercooler as well as increase operating temperatures of the engine and transmission.

To prevent engine damage the vehicle ECU will cut power to the engine to allow it to cool down before internal damage can occur (also known as Limp Mode). Any damage caused by or relating to the fitment of aftermarket accessories will not be covered by factory warranty.

Instructions before use

- The state specific trailer towing regulations must be followed.
- The vehicle speed should not exceed 100 km/h. The vehicle speed should not exceed 70 km/h when changing lanes or steering.
- It is only applicable to center axle trailers, and the load specified in "Recommended towing weight" shall not be exceeded when towing trailers.
- When a new vehicle has been driven or a vehicle has had powertrain parts (Engine, transmission, front and rear axle) changed to new parts, it is recommended not to tow a trailer until the driving distance reaches 800 km.
- Place the load as close as possible to the trailer axle, fix it securely and place it as low as possible, while ensuring

that the towing weight and the load allowed by the tow ball are not exceeded (Refer to "Recommended towing weight" for details). For best stability of the trailer in an unladen vehicle, place the load in the trailer towards the nose within the maximum nose load (Refer to "Recommended towing weight" for details), as this gives the best stability.

- The specified trailer loads are only applicable to an altitude less than 1,000 m. As the air density decreases with the altitude increase, causing the engine output and grade ability to drop, the total mass must be reduced by 10% when the altitude increases by 1,000 m.
- The tires of towing vehicle shall be adjusted to the specified pressure, and the pressure of trailer tires shall also be checked, and on the rear tire pressure, at least 20kPa(0.2bar) above the tire pressure as recommended for normal use(i.e. without a trailer attached).
- If the traffic conditions behind the trailer are invisible through the standard outside rear view mirrors, two additional rear view mirrors must be installed on the reversible boom and adjusted to ensure sufficient rear view at any time.
- The headlamps shall be checked and adjusted if necessary after a trailer is hitched up.
- Always use a safety chain that is suitable for your vehicle and trailer. Have the safety chain passing through the hole at the lower part of the hitch and attach it to the trailer. The safety chain will prevent the trailer from dropping to the ground in the event that the hitch disengages. For proper use and installation, consult the trailer manufacturer.

Starting and Driving

Instructions for driving

- Before driving, check all the safety equipment to ensure safe operation. Ensure that the vehicle is properly maintained to avoid mechanical failure.
- Avoid non-loaded towing vehicle and loaded trailer as much as possible when driving. If it is inevitable, drive at low speed due to improper load distribution.
- As the driving stability of towing vehicle and trailer drops with the speed increase, the speed shall be as low as possible without exceeding the specified speed limit under the improper road, weather and strong wind conditions, especially when driving on a slope.
- When the trailer sways, grip the steering wheel firmly to drive straightforward, and release the accelerator pedal to decelerate the vehicle slowly. Do not attempt to eliminate sway by turning the steering wheel or by emergency braking. The higher the speed, the stronger the trailer swaying. If the sway is still not eliminated after deceleration, stop the vehicle to check if the trailer weight distribution is even and the trailer device is installed securely.
- Under any conditions, the vehicle must be decelerated immediately once minor sway is noticed on the trailer, and never try to eliminate the sway through acceleration.
- If an inertia brake is installed on the trailer, first brake slowly and then brake rapidly when braking is required. This can avoid braking impact due to trailer wheel locking. When driving on a slope, shift to a lower gear immediately to make full use of engine braking action.

- Engine protection mode

The engine has an engine protection mode to reduce the chance of damage if the coolant temperature becomes too high (for example, when climbing up a long or steep grades in high temperature (at temperature over 30°C) with heavy loads, such as when towing a trailer). When the engine temperature reaches a certain level:

- 1 The engine coolant temperature gauge will move toward the H position.
- 2 Engine power may be reduced.
- 3 The air conditioning cooling function may be automatically turned off for a short time (the blower will continue to operate).

Engine power and, under some conditions, vehicle speed will decrease. Vehicle speed can be controlled with the accelerator pedal, but the vehicle may not accelerate at the desired speed.

As driving conditions change and engine coolant temperature is reduced, vehicle speed can be increased using accelerator pedal, and the air conditioning cooling function will automatically be turned back on.

Starting and Driving



Overheating can result in reduced engine power and vehicle speed. The reduced speed may be lower than other traffic, which could increase the chance of a collision. Be especially careful when driving. If the vehicle cannot maintain a safe driving speed, pull to the side of the road in a safe area. Allow the engine to cool and return to normal operation.

Starting and Driving

Recommended towing weight

Towing capacity

Type	GVW (kg)	Gearbox	CVW (kg)	Payload(kg) (exclude driver 75kg)	ATM(braked trailer) (kg)	GTM (kg)
VAN	3500	6MT	2280	1220	2000	5200
VAN	3500	6MT	2300	1200	2000	5200

Caution

- The sum of gross vehicle weight (GVW) and aggregate trailer mass (ATM) shall not exceed the specified gross train mass (GTM) of the vehicle.
- There are two rows of installation holes in the flange ball of the trailer device. The first row of installation holes is suitable for vehicles with a full load mass of 4000 kg or more, and the second row of installation holes is suitable for vehicles with a full load mass of 4000 kg or less.
- ATM(unbraked trailer) is 750 kg.

Starting and Driving

Trailer nose weight

Caution

Never exceed the maximum allowable nose weight, such as the vertical weight on the ball of the trailer. This is very important for the stability of the vehicle and trailer. The technically permissible maximum nose weight shall not be less than 4% of ATM and not be less than 25 kg. The maximum nose weight is $\leq 10\% \cdot \text{ATM}$.

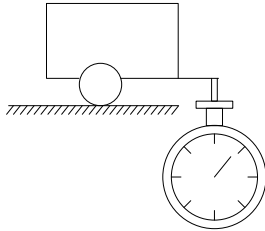

Variant	Maximum nose weight
All models	200 kg

Installation of trailer device

The standard A50-X ball is used in the trailer device. Users can match and install the corresponding trailer according to their needs. If you need to install trailer devices, please contact our Service Dealer.

Maintenance

If the vehicle is often used to tow a trailer, additional maintenance shall be made in the maintenance intervals to ensure continuous satisfaction for the vehicle.

2

Emergency Troubleshooting

- 154 Hazard lamp
 - 154 Warning triangle
 - 155 Jump start
 - 157 Replacing wheel
 - 163 Towing vehicle
 - 164 Draining fuel filter
 - 165 Replacing fuse
 - 173 Replacing bulbs
-

Emergency Troubleshooting

Hazard lamp

When your vehicle needs to stop or slow down, press hazard lamp switch  to light on "direction indicator (green)" on the instrument cluster and flash all direction indicators, warning others and making the police know you are in trouble.

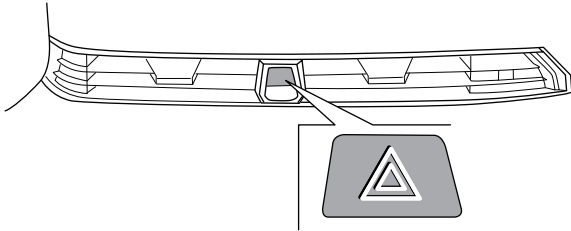

Warning triangle

The warning triangle is placed in the storage box at the right front stepwell of the vehicle.

If you have to pull the vehicle over, you need to place a warning triangle about 100m right behind the vehicle to warn other vehicles incoming.

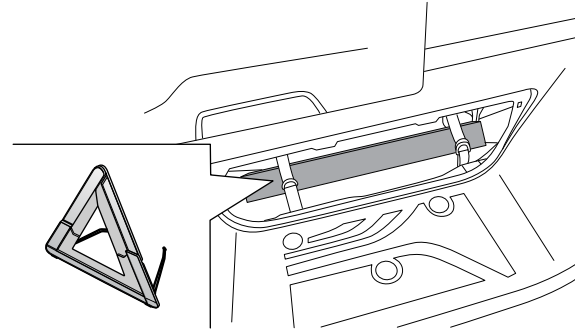

Emergency Troubleshooting

Jump start

Battery disconnection

⚠ Always wear protective gloves and eye protecting glasses when working on a battery.

Do not use naked light, cause sparks or smoke in the area of the battery. You can be seriously injured and the vehicle damaged.

The battery is located under the driver's seat. To disconnect the battery, disconnect the negative (-) earth terminal first and then positive (+). Connect battery, install and secure positive cable (+) first and then negative (-) cable. Smear the terminals with petroleum jelly.

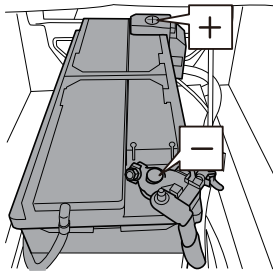

Caution

- Before disconnecting the battery, always shut down the drive motor and all electrical appliances for more than 2 minutes. While disconnecting, never allow the terminal to contact the metal parts of vehicle body. Otherwise short circuit may cause electric spark.
- Electrical system may be damaged if connecting positive and negative cable reversely.

Emergency Troubleshooting

Jump start



Never pull or tow the vehicle to start.

Ensure the rated voltage of two batteries is the same (12 V) and the jumper cable is acknowledged as the cable used for 12V vehicle battery.

Jumper

- Pull two vehicles together as possible.
- Shut down the engine and all electric equipment immediately.
- Connect the positive terminals (+) of two batteries with red jumper cable.
- Connect black jumper cable from power supplying battery negative terminal (-) to earth point (not negative terminal) of battery that need to be powered.
- Ensure all connection mechanisms are well connected.
- Check that the jumper cable is clear of any moving parts when the engine starts.
- Check that the handbrakes of the two vehicles are applied and gear lever is in N position.

Starting

Start the vehicle whose battery supplies power and allow it to idle for several minutes.

- Start the vehicle whose battery needs to be powered.
- Allow the engine to idle for 2 minutes and above after started.

Note: If it fails to start after several attempts, the vehicle may need maintenance.

Disconnecting

- Shut down the engine of the vehicle that supplies power.
- Ensure the cable terminals shall not contact with each other or any moving parts of the engine while disconnecting.
- Remove the jumper cable. Removal is the reverse of connection.

Caution
Before removing the jumper cable, never turn on any electrical device of the vehicle started. Common-rail electronically controlled engines do not allow traction starting.

Emergency Troubleshooting

Replacing wheel

Jack

Location

The jack and the vehicle tool are placed in the storage box at the right front stepwell of the vehicle.

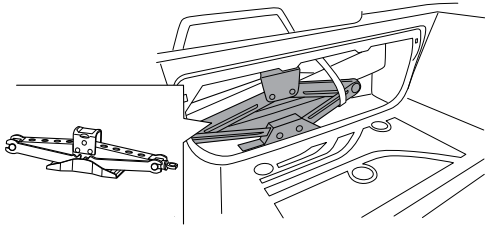

Specification



This jack is just for replacing wheel. Never use it for others.

This jack is just for your vehicle and never uses it for other models.

Spare tire



Check the pressure of spare tire regularly. Using spare tire of incorrect pressure shall influence wheel stability, which may cause danger and permanent damage to the wheel.

The spare tire is mounted at the rear bottom of the body; the wheel nut wrench and the auxiliary rotating extension bar for spare tire removal in the vehicle tool kit can be used to rotate the pillar bolt of drive mechanism, thus releasing or tightening the rope for the spare tire to achieve the function of spare tire replacement.

Removing spare tire

- 1 Take out the vehicle tool.
- 2 Release the spare tire bolt cap with the wheel nut wrench.

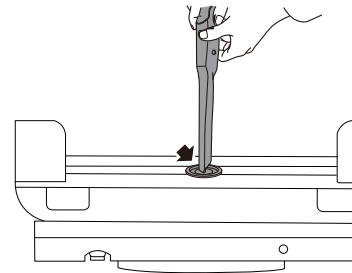

Emergency Troubleshooting

3 Lower the spare tire.

Insert the wheel nut wrench into the spare tire loading/unloading hole, and turn the wheel nut wrench counterclockwise to lower the spare tire until the spare tire reaches the ground.

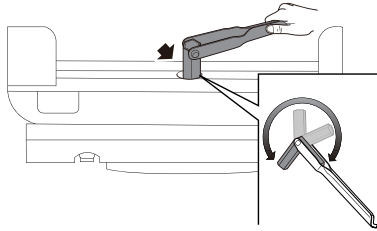

4 After the spare tire reaches the ground, continue to turn the wheel nut wrench counterclockwise and pull out the spare tire. Excessive rotation of the wrench is prohibited, or the spare tire will be damaged.

Caution

After the spare tire is lowered to the ground, the wire rope comes into the state of no load. Continue to turn the wheel nut wrench counterclockwise, and pull out the spare tire to tense the wire rope every 8 to 10 turns so as to avoid wire rope stagnation.

5 Remove the tray from the spare tire.

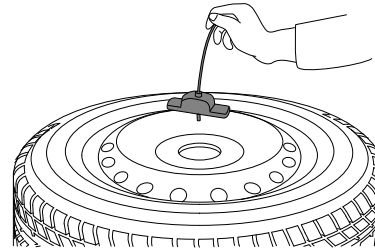

Caution

Be sure to fully lift and tighten the spare tire after the replacement. For steel wheel models, the replaced wheel can be placed at the spare tire position. Since the tire is damaged and flat, it may not be securely fastened. If the replaced wheel is not placed back to the spare tire position, and the wire rope is retracted under no-load condition, it may be easily to cause the wire rope to stagnate in the next use, thus leading to the failure to lower the spare tire smoothly. Therefore, it is necessary to have a person under the vehicle keep pulling the spare tire, to avoid wire rope stagnation. For aluminum wheel models, the replaced main tire cannot be placed back to the spare tire position. Please temporarily put it in the compartment and contact our Service Dealer for the repair of the damaged main tire.

Emergency Troubleshooting

Storing spare tire

- 1 Put the spare tire on the ground, with the tire valve up (be careful not to reverse it).
- 2 Place the spare tire under the rear of the vehicle, place the spare tire tray in the center of the rim, and adjust it to the proper position to make it tightly connected to the spare tire.
- 3 Turn the wheel nut wrench clockwise until a click sound is heard, indicating that the spare tire is installed in place.

Caution
After securing the wheel, check whether the wheel is installed firmly. If the wheel is loose, it may fall off owing to vibration and cause an accident.

- 4 Fasten the spare tire bolt cap.

Replacing tire

Vehicle parking



Park your vehicle in firm and level ground without disturbing traffic or traffic hazard to yourself.

If on the public road, please turn on hazard light and position a warning triangle.

Ensure that the ground where the jack located is firm enough to support the jack and the vehicle to be lifted; otherwise it will move for instability, causing damage to the vehicle and/or personal safety.

Secure other wheels with proper wheel stoppers.

Never use jack if the ground is sloping. If jack is unsuitable to use or you are unsure to complete the task safely, please ask for assistance.

Front wheels must be straight-ahead.

While shutting down the engine, activate the electronic parking brake, and shift the lever to 1/R position.

3

Emergency Troubleshooting

Taking out jack

Turn the rotary switch of the jack in the storage box at the front right stepwell of the vehicle to lower the jack to its lowest position and then take it out with the vehicle tool kit.

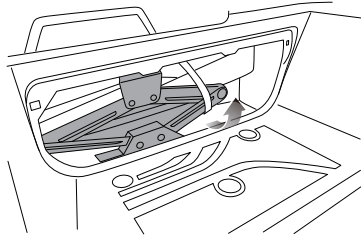

Positioning jack

! Only use jack at specified jacking points. The lifting height shall not be more than the height necessary for tire replacement (such as no more than 30cm above the ground). Before using the jack, ensure all occupants have left the vehicle. No person should place any portion of their body under a vehicle that is supported by a jack. The jack shall be perpendicular to the vehicle body while lifting.

Set jacking points near the wheel to be replaced. Position the jack directly on the firm and level ground under the jacking points, apply the jack auxiliary rotating extension bar and wheel

nut wrench and turn until the jacking head enters the jacking point.

The jacking point for the front wheel is at the bolt head of subframe and swing arm (1).

Jacking point for the rear wheel: with the jacking head turned by 45 degrees, the jacking point is at the leaf spring (2).

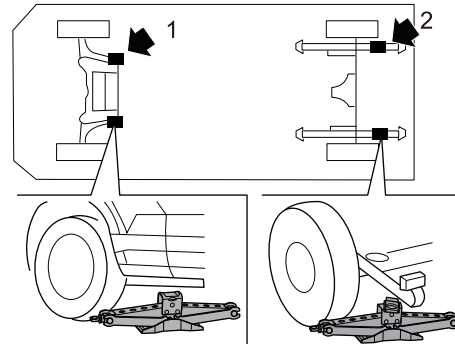

Emergency Troubleshooting

Replacing with spare tire

! During the lifting, do not start the drive motor. Never get under the lifted vehicle.

Before removing the wheel nut, make sure the vehicle is stable and will not slide or move.

Torque wrench shall be used to check exact tightened torque of wheel nuts and tire pressure as soon as possible after replacing the wheel.

Replaced wheel, jack and vehicle tool kit must be stored in specified location. Otherwise they may cause damage or personal injury during impact or heavy braking if casually or improperly placed.

- 1 Remove the spare tire (See “Spare tire” in this section).
- 2 Check the jack is still perpendicular to the jacking points; Change position when necessary.
- 3 Slacken the wheel securing nuts counterclockwise with the wheel nut wrench in the vehicle tool kit, and remove the wheel securing nuts and wheel trim cover.

Note: Before removing the wheel securing nuts, pry the wheel trim cover off with one end of the wheel nut wrench.

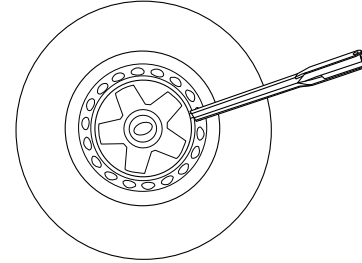

- 4 Lift the vehicle with the jack. Install the auxiliary rotating extension bar and turn the wheel nut wrench clockwise until the wheel to be replaced is just off the ground.

3

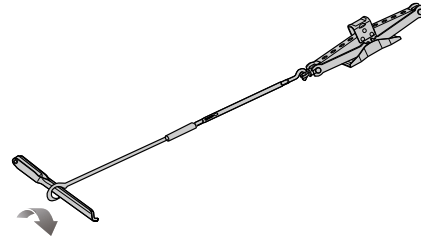

- 5 Carefully remove the wheel.
- 6 Replace with the spare tire and secure wheel nuts clockwise.
- 7 Lower the vehicle body and remove the jack.

Emergency Troubleshooting

- 8 Thoroughly tighten the wheel securing nuts in the diagonal sequence (as shown), with the wheel nut torque of $180\pm 18\text{Nm}$.

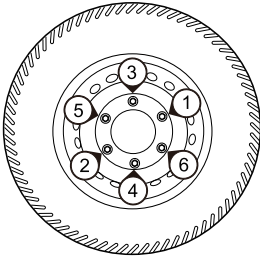

- 9 Install the wheel trim cover in the opposite way.
- 10 Put away the replaced wheel, wheel nut wrench, jack and vehicle tool kit.

Caution

Be sure to fully lift and tighten the spare tire after the replacement. For steel wheel models, the replaced wheel can be placed at the spare tire position. Since the tire is damaged and flat, it may not be securely fastened. If the replaced wheel is not placed back to the spare tire position, and the wire rope is retracted under no-load condition, it may be easily to cause the wire rope to stagnate in the next use, thus leading to the failure to lower the spare tire smoothly. Therefore, it is necessary to have a person under the vehicle keep pulling the spare tire, to avoid wire rope stagnation. For aluminum wheel models, the replaced main tire cannot be placed back to the spare tire position. Please temporarily put it in the compartment and contact our Service Dealer for the repair of the damaged main tire.

Emergency Troubleshooting

Towing vehicle

While towing or being towed, relative national regulations about vehicle towing shall be abided by.

Towing hitch

Front towing hitch

If this vehicle is to be towed from the front, first remove the plastic trim cover at the front towing hitch, and then tighten the towing hitch to the left side of front bumper. This towing hitch is placed in the vehicle tool kit.

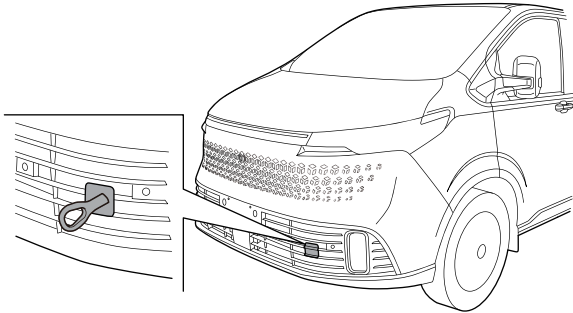

Rear towing hitch

Towing hitch in the rear of the vehicle can be used to tow other vehicles from behind. Before use, remove the plastic cap of the towing hitch.

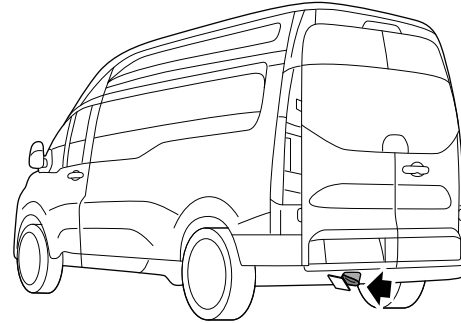

3

Caution

The maximum weight the towing hitch can bear is 1/2 GVW.
Do not tow the vehicle with a weight more than this value.

Emergency Troubleshooting

Towing

Before towed

 To ensure the steering gear can rotate freely, turn the ignition switch to "ON" position and keep it in this position during towing process. This is to ensure the steering is unlocked, and the direction indicators and brake lights can operate.

Being towed

When the vehicle is being towed, release the parking brake and engage N.

 There is no brake booster assist or power steering assist when the engine is not running. In this case, it needs to operate the brake pedal with more force and rotate the steering wheel for longer time and more force.

Caution

The driving distance may not exceed 50 km and the towing speed should not be more than 50 km/h when towing a vehicle, or else the transmission may be damaged. Do not carry out towing in reverse or it will damage the planetary gear mechanism in the transmission.

Draining fuel filter

 Be sure to wear proper gloves to protect hands from diesel.

Drain water according to the following steps:

- 1 Turn off the ignition switch.
- 2 Place a suitable container under the fuel filter drain bolt and unscrew the bolt (1) with an appropriate tool.
- 3 If clean diesel flows out, re-tighten the drain bolt (1), with the tightening torque of 2 ~ 2.5 Nm.
- 4 Start the engine. "Fuel filter water level warning light (yellow)" shall go out after about 2 seconds. Check the filter for fuel leakage.

Caution

If "fuel filter water level warning light (yellow)" in the instrument cluster illuminates while driving, please park the vehicle in a safe place, shut down the engine and drain water.



Do not pour diesel fuel into domestic or public sewage system. Please use locally approved waste treatment equipment.

Emergency Troubleshooting

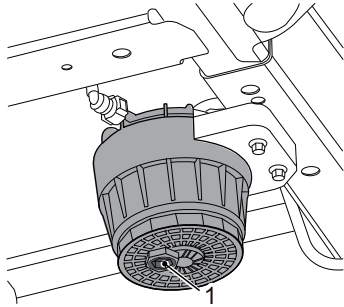

Replacing fuse

Fuses of this vehicle are located in the driver compartment fuse box, front compartment fuse box and the battery fuse box respectively.

Caution

Spillage of liquid to any electric components in the vehicle may damage the components, so it is required to cover any electric components. The content of the fuse specification list according to the vehicle configuration and technical status will be constantly updated, please refer to actual state of your vehicle.

3

Emergency Troubleshooting

Driver compartment fuse box

The driver compartment fuse box is located at the lower left side of the steering wheel. Fuse can be accessed by just removing the cover of driver compartment fuse box.

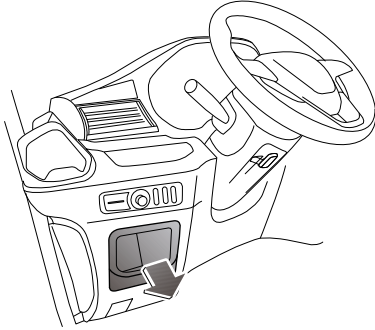

Fuses in driver compartment fuse box can be identified with labels printed on the back of fuse box cover.

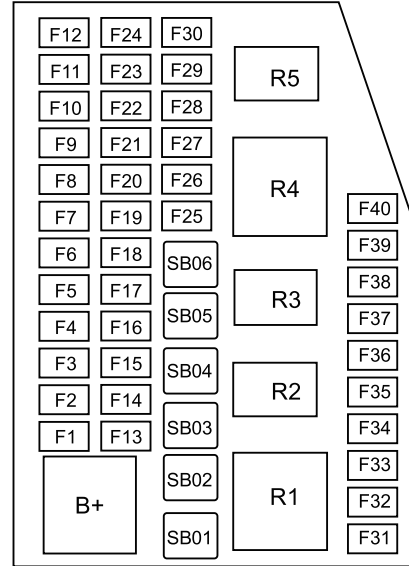

Specification

Code	Specification	Function
F01	15A	TYPE-C ACC(if equipped)
F02	15A	TYPE-C ACC(if equipped)
F03	10A	Power window switch/IBDU ACC relay feedback/360 around-view ECU ACC

Emergency Troubleshooting

Code	Specification	Function
F04	15A	Cigarette lighter ACC
F05	10A	Trailer hitch KL15(if equipped)
F06	15A	Steering wheel heating KL15(if equipped)
F07	10A	Front blower negative feedback
F08	15A	Rear 12V power supply ACC(if equipped)
F09	10A	Driving recorder/ETC/DMS/IBDU feedback/FVCM/MCU KL15 IG1
F10	10A	HCM/Rear PTC/Front AC control panel KL15
F11	10A	ESCL KL15(if equipped)
F12	10A	ACU KL15
F13	10A	OBD KL30
F14	/	Reserved
F15	10A	HCM/Rain sensor/Front PTC KL30
F16	10A	FVCM/LCA/Screen/ATS switch KL30
F17	15A	ESCL KL30(if equipped)
F18	/	Reserved
F19	10A	Front AC control panel/Alcohol lock/Driving recorder/ETC/360/Electric door KL30 video sliding
F20	/	Reserved

Code	Specification	Function
F21	30A	IBDU door lock power supply KL30
F22	20A	IBDU external light power supply 1 KL30
F23	10A	ACU KL30
F24	/	Reserved
F25	/	Reserved
F26	/	Reserved
F27	/	Reserved
F28	/	Reserved
F29	/	Reserved
F30	15A	IBDU external light power supply 2 KL30
F31	10A	Headlamp adjusting motor/Review mirror and headlamp adjusting switch/Combination switch/EPB switch KL15
F32	10A	IPK/ICGM/FICM/SAS KL15
F33	20A	FICM KL30
F34	10A	ICGM KL30
F35	10A	IPK/Screen KL30
F36	15A	TCU KL30(if equipped)
F37	/	Reserved
F38	/	Reserved

Emergency Troubleshooting

Code	Specification	Function
F39	5A	IP Type-C ACC
F40	10A	Exterior rearview mirror heating
SB01	/	Reserved
SB02	/	Reserved
SB03	/	Reserved
SB04	/	Reserved
SB05	/	Reserved
SB06	30A	IBDU external light Power supply 3&4 KL30
R1	/	Reserved
R2	35A	Rear defrost relay(if equipped)
R3	35A	ACC relay
R4	40A	Front windshield heating relay(if equipped)
R5	35A	IG relay

Front compartment fuse box

The front compartment fuse box is located at the right of compartment wall at the hood bottom and behind the right headlamp (viewed from the front of vehicle).

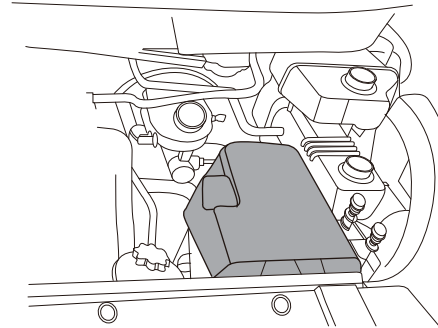

Caution

Before opening the fuse box cover, make sure its surroundings are dry and no fluid flows from any direction into the opened fuse box, otherwise the fuse box will be damaged, leading to serious consequences.

Fuse can be accessed by just removing the cover of front compartment fuse box. Fuses in the front compartment fuse

Emergency Troubleshooting

box can be identified by the label printed at the back of the fuse box cover.

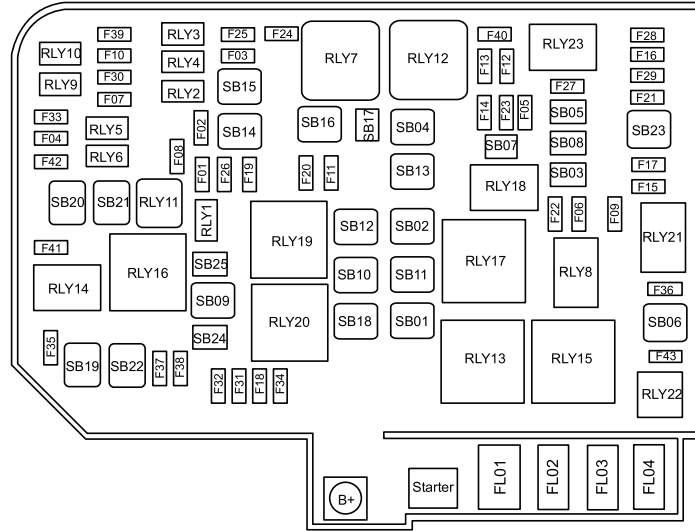

Specification

Code	Specification	Function
FL01	250A	Alternator
FL02	100A	Electric power steering
FL03	80A	Reserved
FL04	80A	Reserved

Code	Specification	Function
SB01	60A	Cooling fan 1/2
SB02	50A	Cooling fan 3
SB03	30A	Rear defrosting
SB04	40A	DCDC Instrument cluster/Entertainment system
SB05	30A	IGN power supply
SB06	40A	ACC power supply
SB07	30A	Reserved
SB08	30A	Electric pedal(if equipped)
SB09	40A	ESP/ESP valve
SB10	40A	HCU(if equipped)
SB11	60A	ESP/ESP motor
SB12	40A	Front blower
SB13	60A	Glow plug
SB14	30A	Right electric side sliding door(if equipped)
SB15	30A	Exterior lights 1&2(if equipped)
SB16	30A	Exterior lights 3&4(if equipped)
SB17	30A	Starter
SB18	40A	Rear blower
SB19	50A	Air suspension(if equipped)
SB20	30A	Reserved

Emergency Troubleshooting

Code	Specification	Function
SB21	40A	Windshield heating 1(if equipped)
SB22	40A	Windshield heating 2(if equipped)
SB23	30A	Reserved
SB24	15A	Seat heating(if equipped)
SB25	30A	Air suspension(if equipped)
F01	10A	Air conditioning compressor
F02	15A	Horn
F03	15A	Reserved
F04	30A	Front wiper
F05	10A	Main relay power supply 4 (Glow plug/HCU)
F06	30A	Fuel heating
F07	10A	Reserved
F08	15A	Automatic transmission(if equipped)
F09	15A	SCR power supply(if equipped)
F10	7.5A	Reserved
F11	30A	Reserved
F12	10A	Main relay power supply 1(EMS)
F13	15A	Main relay power supply 3/Water pump
F14	20A	Main relay power supply 2(EMS)
F15	10A	EMS

Code	Specification	Function
F16	5A	EMS KL15
F17	25A	Reserved
F18	30A	Front compartment fuse box/Air conditioner/ OBD
F19	30A	Trailer module 1
F20	30A	Trailer module 2
F21	5A	ESP/EPS/SAS KL15
F22	25A	Fuel pump
F23	20A	PM particulate/Nitrogen oxygen sensor
F24	10A	Starter feedback(if equipped)
F25	20A	Parking heater
F26	10A	Front washing
F27	10A	Brake switch
F28	5A	Radar/Seat heating KL15
F29	5A	Automatic transmission KL15
F30	15A	Reserved
F31	25A	Driver's side electric window
F32	25A	Passenger side electric window
F33	10A	Child protection lock
F34	30A	Door lock power supply(if equipped)
F35	20A	Reserved

Emergency Troubleshooting

Code	Specification	Function
F36	25A	Trailer hitch(if equipped)
F37	30A	Reserved
F38	30A	Reserved
F39	30A	Reserved
F40	30A	PTC2(if equipped)
F41	30A	PTC1(if equipped)
F42	10A	Reserved
F43	15A	Reserved
RLY1	/	Air conditioning compressor relay
RLY2	/	Horn relay
RLY3	/	Reserved
RLY4	/	Reserved
RLY5	/	Front wiper relay
RLY6	/	Front wiper high/low speed relay
RLY7	/	Starter relay
RLY8	/	Fuel heating relay
RLY9	/	Reserved
RLY10	/	Reserved
RLY11	/	Reserved
RLY12	/	Main relay
RLY13	/	Main and auxiliary fan low speed relay

Code	Specification	Function
RLY14	/	PTC1 relay(if equipped)
RLY15	/	Main fan high speed relay
RLY16	/	Front windshield heating relay 1(if equipped)
RLY17	/	Auxiliary fan high speed relay
RLY18	/	Fuel pump relay
RLY19	/	Front blower relay
RLY20	/	Rear heater blower relay
RLY21	/	SCR relay(if equipped)
RLY22	/	Reserved
RLY23	/	PTC2 relay(if equipped)

Emergency Troubleshooting

Battery fuse box

The battery fuse box is located on the battery positive terminal under the driver's seat.

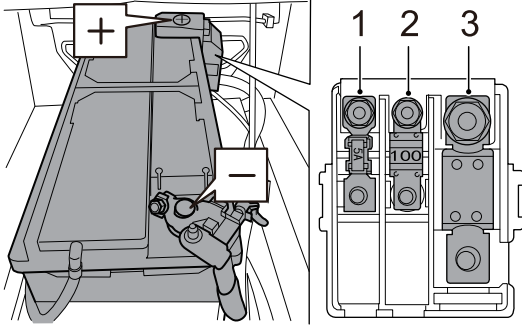

Specification

Code	Specification	Function
BF01	MINI 5A	IBS (Intelligent battery sensor)
BF02	MIDI 100A	Battery connected to IEC (driver compartment fuse box)
BF03	MEGA 500A	Battery connected to UEC (front compartment fuse box)

Fuse replacement

⚠ Only replace with fuses of the same specifications/rated current. Installing nonspecific fuse will damage electrical system and even cause fire. Before attempting to replace the fuse, ignition switch and all electrical devices shall be turned off. Any unauthorized change to vehicle electrical system will cause serious adverse effect and fire on the electronic management system.

Pull the fuse outward with puller provided in fuse box to remove the fuse. Internal wiring of the fuse can be used to identify blown fuse (arrowed).

Note: Repeated failure with the same fuse is the indication of circuit failure. Please contact our service dealer as soon as possible.

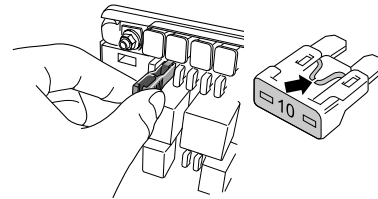

Caution

Unauthorized change to electrical system of the vehicle will invalidate the warranty.

Replacing bulbs

Before replacing any bulbs, turn off ignition switch and light switch to prevent any possible short circuit.

When removing or installing bulbs, never touch the bulb with hands and if touched, clean hand trace on the bulb with cloth or alcohol.

Caution
Replace with bulb of the same category and specification as the original one.

Bulb specification

Bulb	Specs
Rear fog light	P21W
Reverse light	W16W

Maintenance and Service

- 176 Safety
 - 177 Scheduled maintenance
 - 178 Owner's check
 - 179 Front compartment hood
 - 181 Front compartment
 - 181 Engine oil
 - 183 Coolant
 - 185 Brake fluid
 - 186 Washer fluid
 - 187 Washer jet
 - 187 Wiper blade
 - 188 Seat belt
 - 189 Battery
 - 193 Tires
 - 195 Other maintenance
-

Safety

During vehicle inspection or maintenance, take care to reduce risks of personal injury or vehicle damage, and always observe the following safety precautions.

 **Turn off the ignition switch, unless otherwise specified in special procedures.**

When the engine is running, be sure to keep hands, tools and clothes away from drive belt and belt pulley.

The radiator fan may start at any time (even when the engine is not running). Always ensure your hands, loose clothing (such as ties, scarves, etc.) stay away from fan blades. After the engine is started/running, many components under the engine hood will be hot, such as the engine, exhaust system, cooling system and power steering fluid reservoir. Do not touch until it is cooled down.

The engine fuel system is a high-pressure common rail system. Since the pressure in the high-pressure common rail is huge, unauthorized removal may cause personal injury. Never remove the system without permission.

Do not touch wires or components with the ignition switch in "ON" position. Keep in mind that the batteries and wires carry with high current or voltage possibly causing personal injury. Avoid short circuit.

 **Do not start the engine in unventilated place as poisonous gases exhausted is very dangerous.**

If possible, operate the engine compartment after engine shutdown and battery disconnection (see "Jump start" in Emergency Troubleshooting section). If components under the engine hood shall be inspected when the engine is running, make sure the vehicle is on a level ground, the parking brake has been applied and the shift lever is in N position. Keep the matches and open fire away from the battery area and all fuel related components. Do not smoke near these areas and components.

Most fluid used for motor vehicles are toxic. Do not drink or contact with the skin or eye. These fluid include battery acid, coolant, brake fluid, fuel, detergent, lubricating oil, refrigerant, etc. Please wear protective gloves to refill the fluid. And observe all instructions on labels and containers. When operating on or under the vehicle, wear protective glasses if it is possible to touch splashed or fallen articles and sprayed fluid.

Long-term contact with engine oil may cause skin diseases, including dermatitis and skin cancer. Clean it thoroughly after contact.



Be sure to keep children and pets away from the vehicle. Nobody is allowed to stay in the vehicle (except those work in the vehicle according to your instruction). Be sure to keep children away from oil, fluid and lubricating grease.

Scheduled maintenance

Regular maintenance is the key to economy, safety and reliability for your vehicle and it must be remembered that the responsibility for maintaining your vehicle in a safe, roadworthy condition rests ultimately on you, the owner/operator.

Necessary maintenance and the intervals have been specified to maintain your vehicle properly. Regular vehicle maintenance shall be done by Our Service Dealer in accordance with Warranty & Service Handbook.

It is in your best interest to have your vehicle regularly maintained in accordance with regulations.

Our Service Dealers are recommended as they have qualified personnel, required facilities and can offer the unique pre-planned service which will give maximum vehicle reliability.

Maintenance and Service

Owner's check

The following are a few simple but important checks which you should make at regular intervals before driving to ensure reliable, economic operation:

Daily checks

- The function of lighting (make sure all lens are clean), horn, instrument cluster, warning lamps and indicator lamps, wipers and washers.
- Operation of seat belts.
- Correct functioning of brakes.
- Visually check if there is water, oil, fuel, exhaust fume and other leakage under the vehicle.

Weekly checks or check before a long journey

- Check for fluid level / fluid fill-up.
 - Engine oil
 - Coolant
 - Windshield washer fluid
 - Brake fluid
- Check for condition and pressure of all tires (including spare tires).
- Check and operate AC system.

Arduous use

For vehicles often subject to arduous use it is recommended that service intervals are reduced.

Regular vehicle maintenance shall be done by Our Service Dealer in accordance with Warranty & Service Handbook.

Front compartment hood

Open hood

- 1 In the direction as shown in the figure, pull up twice the unlock handle of front compartment hood below the instrument desk on the driver side to unlock the front compartment.

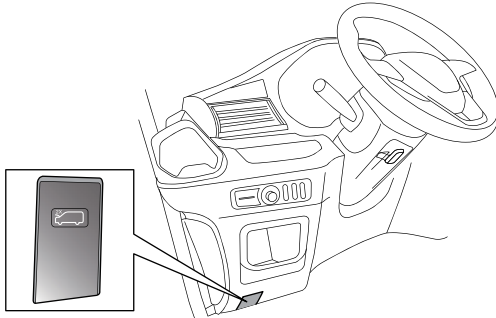

- 2 Lift the front compartment hood cover, use the left hand to lift the support rod, and install the end of it into the mounting slot in the hood.

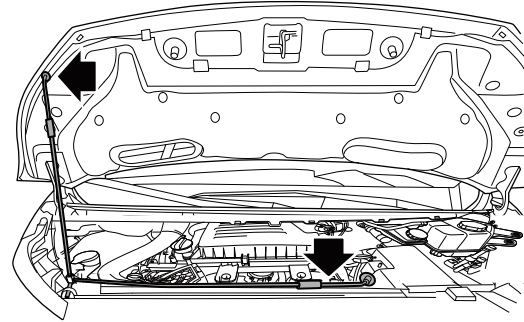

Maintenance and Service

Close hood

! When the ignition switch is in "ON" position, the radiator fan may operate at any time (even if the engine is not running). Always ensure your hands, loose clothing (such as ties, scarves, etc.) stay away from fan blades.

If the engine is running, keep your hands, clothing, etc. away from the rotating pulley, drive belt, fan blades and other devices.

When closing, support the front of the hood with one hand, pull the support rod out of the mounting slot with the other hand and clip it into the fixing points horizontally, then close the hood. When the front of the hood is approximately 20cm from the front bumper, let the hood close by gravity. Finally attempt to lift the hood to check if the locking mechanism is properly engaged.

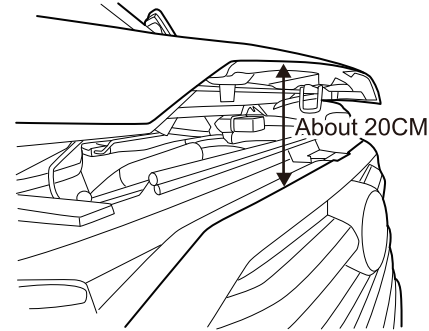

Caution

Before closing, check that no tools, rags, equipment, etc. left under the hood.

Front compartment

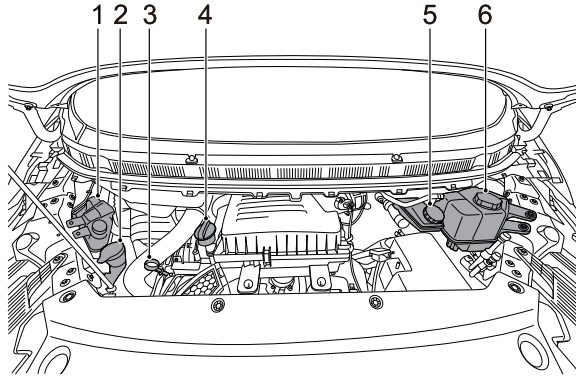

- 1 Cryogenic circulating coolant reservoir
- 2 Washer fluid reservoir
- 3 Oil dipstick
- 4 Oil filler cap
- 5 Brake fluid reservoir
- 6 Engine coolant reservoir

Note: *The oil dipstick handle is marked in yellow, easy to identify.*

Engine oil

It is recommended to use oil of correct grade.

SAE 5W-30 ACEA C3 Long-life or higher-grade oil is recommended.

Our Service Dealer are ready to provide you with the latest updates and improvements on recommended oil. If you are using your vehicle in areas of extremely low temperatures, it is recommended to use SAE 0W-30 ACEA C3 Long-life oil for your vehicle.

Caution

Don't use the engine oil not conforming to the above specifications. Improper use of oil may cause damage to the engine, thus the warranty will become invalid.

4

Inspection and refill



Do not exceed the maximum mark when refilling.

Long-term frequent exposure to used engine oil can cause severe skin disease. Please avoid excessive skin contact with engine oil, in case of contact, rinse your skin thoroughly.

Keep the engine oil out of the reach of children and pets.

Maintenance and Service

Park the vehicle on a flat ground, idle the engine for 1 ~ 2 minutes, then turn off the ignition switch and wait for about 10 minutes to check the oil level.

Pull out the oil dipstick and wipe the blade with a paper or lint-free cloth. Completely insert the oil dipstick back and then pull out. The oil level indicator must be between MAX and MIN marks.

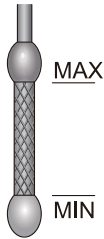

Caution

Check the engine oil level frequently, and refill as necessary. Both excessive and insufficient refilling of engine oil is likely to damage the engine, and the damage are not covered by warranty.

If you need to refill, please turn counterclockwise to unscrew the oil filler cap, then add new oil of correct specification. The amount of oil required from MIN to MAX is about 1L. Repeat the oil level check process after the oil drops into the tank. Refill as necessary until the oil level is correct.



Empty containers and used oil can not be discarded randomly, so as to avoid environment pollution.

Engine oil consumption

The engine oil consumption is affected by a variety of factors (these factors also affect fuel consumption), of which the oil type and driving pattern (especially in the "running-in" period) are the two most important factors. Generally, the engine oil consumption is higher in the "running-in" period and in continuous high-speed operation. You must follow the suggestions on driving tips in this Handbook. See "Driving" in Starting and Driving section.

Coolant



Coolant is harmful if swallowed. Do not allow coolant to contact the eyes or skin. If it does, rinse immediately with plenty of water.

Please add correct specification coolant. Never driving the vehicle if coolant of correct specification is not filled. Coolant specifications see “Recommended fluids” in General Technical Parameters section.

At specified intervals the cooling system should be drained, flushed and refilled with the correct amount of coolant.

Caution

When charging or replacing coolant, only the specified coolant can be used. The use of non-recommended coolant could cause damage to the cooling system and may invalidate the warranty.

Inspection and refill



Do not remove the reservoir cap while the system is hot, for escaped water vapor or hot coolant may cause injury. If coolant has to be charged when the system is hot, wait for 10 minutes, place a thick cloth over the reservoir cap and turn the cap slowly counterclockwise to release the pressure in the reservoir before removing the cap.

Always check the coolant level with the vehicle on level ground and the cooling system stationary (cold condition).

The level is visible on the coolant reservoir and the normal level shall be between MAX and MIN marks.

If the level drops to the MIN mark, clean the area around the coolant reservoir cap and rotate the cap counterclockwise to remove it. Top up with the specified fluid between MAX and MIN marks. Install the reservoir cap.

Note: The coolant may expand when it becomes hot, so the liquid level may be higher than the level mark.

Note: Excessive refill may cause the coolant overflow when the engine temperature rises, which undermines the cooling effect. Simply refill the fluid to the indicated level when the engine is cool.

Maintenance and Service

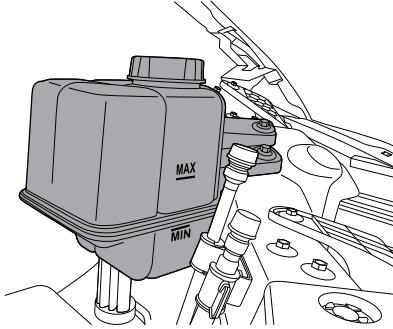

of appropriate proportion based on the local temperature. (Refractometer T10007 can be used to detect the freezing point of the coolant)

Caution

If the level has fallen appreciably, or topping-up is required frequently, suspect leakage or overheating and contact our Service Dealer for inspection.

Precautions for cold weather

In order to reduce possible problems which may occur in cold weather, please consider the following suggestions:

- Since the standard freezing point of the coolant used in the vehicle is -35°C (with the mixture ratio of coolant stock solution and water of 1:1), it is necessary to park the vehicle in areas where the coolant temperature can be maintained above -35°C .
- If you are using your vehicle in extremely cold areas where the ambient temperature is below -35°C , please use the coolant

Brake fluid

! If there is an appreciable drop in the level of the brake fluid, contact Our Service Dealer as soon as possible.

Use only new, specified brake fluid. Use of old or unspecified fluids can cause loss of braking performance.

Brake fluid cleanliness is essential. Any dirt entering the system can cause loss of braking performance.

Do not allow brake fluid to contact the skin or the eyes; If it does, rinse immediately with plenty of water. Keep brake fluid out of the reach of children.

Do not allow brake fluid flowing onto the engine, otherwise it may be ignited when the engine heats up, causing a fire and damage to the engine.

Note: Fluid used in the hydraulic clutch also comes from the brake fluid reservoir.

Caution

- Only top up the brake master cylinder with brake fluid complying with specification DOT4. Do not use any other type of brake fluid.
- Brake fluid will damage paintwork if allowed to contact it. Wipe clean immediately and flush with water.

Inspection and refill

Be sure to check the brake fluid level after the vehicle is parked on a flat ground and the brake system is in cold state. Brake fluid level is visible on the reservoir and the normal level shall be between MAX and MIN marks. If the level drops to MIN mark, clean area around the filler cap and then turn counterclockwise to remove the reservoir cap. Fill up specified new brake fluid between MAX and MIN marks and install the reservoir cap.

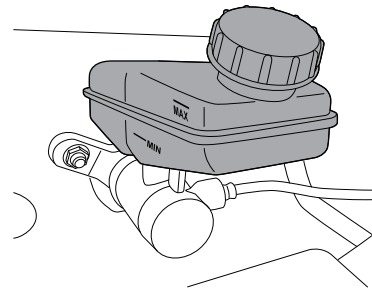

If the level falls below MIN mark, "brake system warning light (red)" on information cluster will light on. This indicates a fault in the braking system which must be investigated immediately. If driving, IMMEDIATELY bring the vehicle carefully to a halt. Contact our Service Dealer for service as soon as possible. Do NOT drive the vehicle.

Maintenance and Service



Never discard used brake fluid casually to avoid polluting the environment.

Washer fluid

Inspection and refill

! Driving with a non-operational washer system can be dangerous; always check it before driving.

The windshield washer reservoir is located in the front compartment. To top up, lift the front of the filler cap to fill washer fluid and then reinstall it. Washer fluid specification see “Recommended fluids” in General Technical Parameters section.

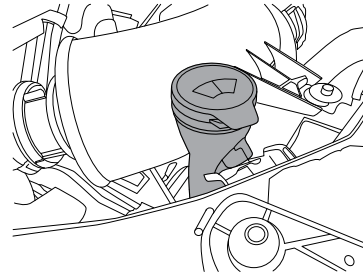

Caution

Do not use washer fluid that does not comply with requirements. Do not use tap water as mineral substance in tap water will easily block windshield washer fluid pipeline or jet.

Washer jet

Adjusting and cleaning

Prior to carrying out jet adjustment or cleaning, ensure that the washer reservoir is topped-up. Use a piece of thin wire or a pin to carefully clean the jets if the jet is blocked.

The direction of washer jet has been set in manufacturing works and normally no adjustment is required. If any adjustment is required, carefully insert a fine needle into the jet hole to re-position the jet to direct the spray direction towards the middle of the windshield.

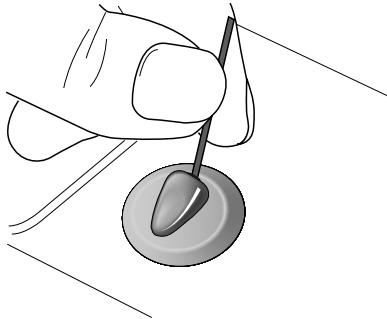

Wiper blade

Inspection

Examine the edge of the blade for roughness or damage, and check that the blade rubber is secure throughout its length.

Note: Traces of grease and other impurities on the rubber can prevent the wipers from working correctly, and can also damage the windshield glass.

Replacement

- 1 Make sure the front compartment hood is closed.
- 2 Lift the wiper arm from the windshield and keep the wiper blade at right angles to the arm.
- 3 Place a towel to prevent the wiper from bouncing back and breaking the glass. Hold the clips on both sides by hand, turn the wiper blade and take it out.

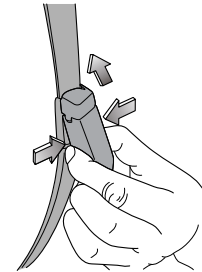

Maintenance and Service

- 4 Take the new blade, insert it diagonally into the card slot, pinch the clips on both sides, and push it into the card slot.

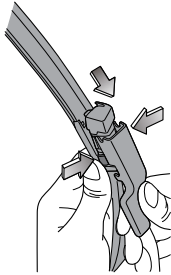

Maintenance and service

Wash with good cleaner or neutral detergent and wipe clean with soft dry cloth that is free of lint.

Seat belt

Inspection

! The belts also have a sensitive retractor which is designed to lock only during heavy acceleration, deceleration or, for example, on tight bends.

Do NOT attempt to test the locking device by intentionally "launching" your upper torso in a forward direction.

Check ALL seat belts as follows:

- Inspect all belt anchorage points for security.
- Insert the tongue into the buckle and check for a positive locking action. Push the red button and check if the locking tab pops neatly.
- With the belt half unreeled, hold the tongue and give it a sharp pull. Check if the safety device can be locked automatically and prevent further looseness.

Maintenance and service

 **Do not attempt to repair the retractor or buckle mechanisms, or to modify the seat belts in any way. Seat belts subjected to strain as a result of an accident shall be replaced and the anchorage points checked by Our Service Dealer.**

Regularly inspect the belt webbing for signs of abrasion or wear, paying particular attention to the anchorage points and adjusters.

Clean the seat belt with a sponge dipped in warm water and mild soap; it can be naturally dried, and should not be directly heated or exposed to sunlight. Do not allow water to enter the retractor. Never bleach or color seat belt as its strength may be reduced.

Battery

Warning on battery :



Wear goggles!



The acid liquor in battery is strongly corrosive. Ensure to wear protective gloves and goggles!



Any open fire, spark, hard light and smoking is strictly forbidden!



Explosive gas mixture may be generated during battery recharging!



Ensure to keep any child away from the acid liquor and the battery!



There may be risks of injury, corrosion, accident and fire during operations on the battery and any electric apparatus in the vehicle!

Ensure to wear goggles. Do not let any acid or leaded grains into your eyes or onto your skin or clothes.

The acid liquor in battery is strongly corrosive. Ensure to wear protective gloves and goggles.

Maintenance and Service



Do not turn over the battery, or acid liquor may be discharged from the exhaust vent. If any acid liquor touched your eyes, immediately flush with clean water for several minutes before seeing the doctor. If any acid liquor spills onto your skin or clothes, immediately neutralize it with thick liquid soap, and then flush with plenty of water. If any acid liquor is swallowed accidentally, see the doctor immediately.

Any open fire, spark, hard light and smoking is strictly forbidden. During working on cables and electric devices and removing electrostatic loads, avoid generating any spark. The electrodes of battery can NEVER be short-circuited, or may cause injury due to large energy spark.

Explosive gas mixture may be generated during battery recharging. The gas vent of battery should be kept unblocked to discharge the gas correctly. During recharging, the battery should be located in a space with good ventilation.

Ensure to keep any child away from the acid liquor and the battery.

Turn off the engine, ignition switch and all the electrical appliances before working on electrical appliances. Remove the negative cable of battery. When replacing bulbs, only the lights are required to be shut down.



Pay attention to the polarities of power supply. Before powering on, the matches of polarities must be checked.

The duration of each powering on should not be less than 5 seconds. Try to avoid powering on and off too frequently.

When removing the battery, please remove the negative cable before positive cable.

Before powering on the battery again, all of the electric devices should be shut down. First connect the positive cable, then the negative one. Never connect the cables incorrectly - risk of fire!

Unauthorized removing and installing of battery is strictly forbidden. In some cases, such operations may cause severe damage to the battery and fuse box. Please contact Our Service Dealer.

Do not disconnect the battery when the ignition switch is on or the engine is running, otherwise it may damage the electrical appliances (electrical components).

To prevent the battery housing from exposing to ultraviolet ray, do not expose the battery under the sunshine.

Duration of storing the vehicle

If the vehicle is to be parked for an extended period of time, the static current electrical appliance (like clock, security devices) will drain the battery, and the battery has to be recharged. To avoid such case, charge the battery or disconnect the battery negative cable during the vehicle parking.

Note: Please pay attention to the warnings & instructions for battery before working on it.

Caution

Ensure to turn off the ignition switch during storing, otherwise the storing duration can be reduced significantly.

Operating in winter

There are some strict requirements on operating the in-car battery in winter. In addition, the battery can only provide the starting power which is a part of that in normal temperature. We suggest to have the in-car battery checked by Our Service Dealer before the cold season, and recharge it if necessary.

If the vehicle is not used for weeks in cold season, please remove the in-car battery and store in an ice-free room, to prevent it from freezing and damage.

Recharging the battery with ground equipment



Do not recharge any frozen battery, or may cause explosion! Even if the battery is unfrozen, there may be acid liquor spilling out and cause corrosion. Any frozen battery must be replaced.

Turn off the ignition switch and all of the electric devices before recharging.

If the vehicle has been stored for long term and cannot be started due to undervoltage (general terminal voltage \leq 12V), the battery must be removed from the vehicle and recharged with ground equipment (follow the instructions provided by the manufacturer of the recharging equipment).

During recharging with low current (e.g., a small recharging device), it is unnecessary to remove the connecting cables of battery. However, please ensure to read the instructions from the manufacturer of the recharging device.

Before quick recharging (i.e., high current recharging), both of the cables must be removed.

Note: Please pay attention to the warnings & instructions for battery before working on it. During recharging, the recharging device can only be connected after the terminal clamps of recharging device is connected to the electrodes of battery as required. After the recharging is finished, firstly turn off the recharging device, remove the power

Maintenance and Service

cable, and then remove the terminal clamps of recharging device from the battery.

Caution

- Keep any child away from the battery, acid liquor and recharging device.
- The battery can only be recharged in space with good ventilation. Smoking is strictly forbidden. Ensure to keep away from open fire and sparks, because explosive gas mixture may be generated during recharging of the battery.
- Protect your eyes and face, never be too close to the battery. If any acid liquor touched your eyes or skin, immediately flush with clean water for several minutes before seeing the doctor.
- There is a risk to quickly recharge the battery, which should be done by Our Service Dealer due to requirements on the special recharging device and knowledge.
- Any frozen or unfrozen battery must be replaced. Because cracks may be found on the frozen battery housing. It may cause leak of acid liquor and damage to the vehicle.

Removing the battery

Shut down the ignition switch and all of the electric devices before removing the battery. To remove the battery, firstly remove the negative cable and then the positive cable. And then remove the bolt on the mounting bracket of battery to remove the battery.

Replacing the battery

The battery installed on your vehicle is designed for the corresponding mounting location. To replace the battery, please ensure to use one with the same voltage (12V), structure and safety label. The current strength and capacity should be same with the original battery. Our Service Dealer can offer you with genuine batteries. When replacing the battery, please ensure that the ignition switch is powered off and all of the electric devices are shut down.



Concerning the disposal of used battery, it is suggested to have the battery replaced by Our Service Dealer. Additionally, the battery can never be treated as household garbage because it contains sulfuric acid and lead.

Installing the battery

Before installing the battery, please power off the ignition switch and shut down all of the electric devices. Locate the battery into the desired position, and fix it with battery bracket. When connecting the battery, please fix the positive cable before the negative cable.

Caution

To prevent the battery from discharging, please turn off the ignition switch when you leave the vehicle.

Tires

! DEFECTIVE TIRES ARE DANGEROUS! Do NOT drive your vehicle if any tire is excessively worn or damaged, or is inflated to an incorrect pressure.

Frequently inspect the tires and sidewalls for any sign of distortion (bulges), cuts or wear. Flints and other sharp objects should be removed with a suitable blunt tool. If neglected, they may work through the tire.

Tire pressure

! Driving with incorrectly inflated tires can affect vehicle stability, increase rolling resistance, and cause rapid tire wear and possible permanent damage to the cords of the tire casing.

Remember tire wear and inflation pressure regulations. It is the driver's responsibility to ensure that the tires meet these requirements.

Check the tire pressures weekly, including the spare tire, and if necessary, adjust in accordance with pressure requirements on the "tire pressure sign" on the B pillar. This Handbook introduces the correct tire pressure in cold condition, see "Wheel and tire" in General Technical Parameters section.

The spare tire should be maintained at the highest recommended pressure and adjusted before use. Pressure

should be checked with an accurate Tire Pressure Gauge when the tire is cold instead of decreasing the value under warm condition as the pressure will be higher than normal pressure due to temperature. Always refit the valve caps to prevent dirt entry into the valve mechanism.

A natural pressure loss will occur with time; any unusual pressure loss should be investigated and rectified.

Note: Specified pressure applies to a cold tire, while the pressure of hot tire should be higher.

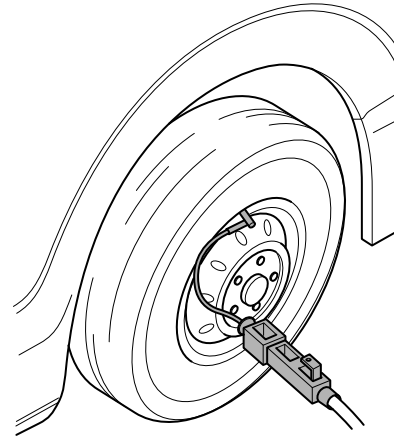

See "Tires" in Starting and Driving section.

Wear indicator

There is wear indicator in tread for all original tires. When the tire has worn down until 1.6 mm of the tread is remaining the wear indicator will appear across the full width of the tread pattern.

A tire should be replaced immediately where any part of the wear indicator becomes visible. However it is in your interest to note that tire safety and performance tends to reduce before the legal limit is reached. For example, badly worn tires will increase the risk of aquaplaning.

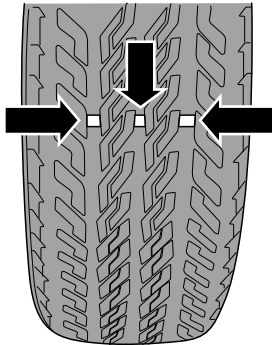

Tire check and rotation

In order to achieve even tire wear, it is recommended to check the tires every 5,000km, and check the wheel alignment parameters under the curb weight of the entire vehicle as required. If irregular wear is found, the tires position should be changed, and wheel alignment adjustments should be made if necessary. During the tire rotation, check the tires for correct dynamic balance.

During the tire rotation, check for uneven wear and damage. Abnormal wear is usually caused by incorrect tire pressure, poor wheel alignment, poor wheel dynamic balance, emergency braking or cornering. Check the tread or the side of the tire for collision damage or bulges. If one of these conditions is found, the tire shall be replaced. If fabric or cord is visible, the tire shall also be replaced. After the tire rotation, adjust the inflation pressure of the front and rear tires as shown on the tire pressure label on the vehicle and check the tightness of the wheel nuts.

Tire rotation method

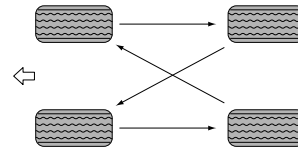

Other maintenance

Vehicle cleaning



For the first driving after washing the vehicle, gently apply the brake pedal several times to ensure all moisture is removed from the brake discs.

Carefully clean tires. Never use a high pressure jet as it may damage tires. If any damage found, replace the tire.

Flushing water on the forepart of the interior car (close to the dashboard area) is prohibited so as not to cause any damage to some related parts.

Careful attention to the following will help to retain the value of your vehicle:

- Clean the vehicle with cold or lukewarm water. Hot water may impair vehicle paint in extremely cold weather.
- No vehicle washing under strong direct sunlight during hot weather.
- Use special vehicle cleaner to remove grease and tar spots on vehicle body and while still wet, wash the paintwork using a soft sponge and generous quantities of water containing car shampoo. Rinse thoroughly and dry off with a chamois leather.
- When cleaning the vehicle with a hose, it is prohibited to spray the water directly to the window, the door, or the brake through the gap of the wheel.

- After cleaning, inspect the paintwork for damage and stone chips; apply touch-up paint if necessary. Use the polishing wax to protect the paintwork from time to time.
- When using high pressure cleaning equipments, the water jet shall be kept moving. Do not directly wash the engine, radiator, door gap, seals, electrical components or components connected to it.

Note: Remove apparently harmless looking but actually aggressive particles from the paintwork immediately - e.g. bird droppings, tree resins, insect remains, tar spots, road salt and industrial fall-out. Otherwise permanent staining or damage will be produced.

Caution

It is prohibited to open the engine hood and directly rinse the engine compartment, as this may cause short circuits of electrical components in the engine compartment. Don't use steam to clean the underbody, wheelhouse or transmission portion, as this will damage the protective wax layer.

Engine carbon deposit cleaning

In view of the quality of domestic oil products, it is recommended that you carry out engine carbon deposit cleaning after driving 15,000 ~ 20,000 km to ensure the normal performance of the engine. For details, please consult Our Service Dealer.

Anti-corrosion of underbody

The underbody of your vehicle has been treated with anticorrosion. Check underbody anti-corrosion regularly.

Use a water jet to remove accumulations of caked mud or debris on underbody. Especially in winter, when salt is used on icy and snowy roads.

Seat and trim

Often use vacuum sweeper or soft brush to clean dirt and dust accumulated on fibers. Often use clean cloth to wipe the trim. Use special cleaner to remove general trim dust, staining or spots. Use special cleaner to clean leather parts.

Door seal

To prevent rubber door seals freezing during cold weather, rubber maintenance products or silicone spray shall be used for protection.

Window glass

Often use glass cleaner to clean window glass. The headlamp lenses are clear plastic. Use good cleaner or neutral detergent rather than abrasive or chemical solvent to wash.

Exterior trimming

Do not use chemical solvents to wipe, especially avoid using reagents containing benzene and naphtha solvents.

General Technical Parameters

198 Major vehicle dimension parameters

199 Vehicle weight parameters

200 Vehicle performance parameters

201 Main engine parameters

202 Chassis technical parameters

203 Recommended fluids

204 Wheel and tire

205 Wheel alignment parameters

General Technical Parameters

Major vehicle dimension parameters

Model	SV65C
Driving type	Front-engine, front-wheel-drive
Length, mm	5372
Width, mm	2030
Height, mm	1999, 2420
Wheelbase, mm	3357
Front/Rear overhang, mm	1018/997
Front/Rear track, mm	1744/1766
Minimum turning circle diameter, m	13.4±1

General Technical Parameters

Vehicle weight parameters

Model	SV65C	
Gross vehicle weight, kg	3500	3500
Curb weight of a vehicle, kg	2280	2300
Axle load (Front/rear axle load under gross vehicle weight), kg	1720/1780	1730/1770
Passenger capacity	3	3

General Technical Parameters

Vehicle performance parameters

Model	SV65C
Engine type	SC20M150.1Q6
Maximum design speed, km/h	150
Maximum gradeability, %	40
Emission level at delivery	Euro 6

General Technical Parameters

Main engine parameters

Engine type	SC20M150.1Q6
Type	Common rail direct injection (CRDI) diesel engine with turbocharger and intercooler
Displacement, L	1.996
Number of cylinder	4
Bore*Stroke, mm*mm	83*92
Volume compression ratio	(15.9±0.4):1
Maximum net power, KW	108.5
Engine speed at maximum net power, rev/min	3500
Max. torque, Nm	375
Engine speed at maximum torque, rev/min	1500 ~ 2400
Idle speed, rev/min	750
Fuel type and grade	Diesel
Fuel tank capacity, L	80

General Technical Parameters

Chassis technical parameters

Items	Parameters
Front suspension	Mcpherson independent suspension
Rear suspension	Leaf spring non-independent suspension
Leaf spring type	Taper leaf spring
Leaf spring specification	80、100 (N/mm)
Wheel dynamic balance requirement	Residual dynamic unbalance on both sides of wheel assembly shall be less than 10g
Sound free travel of brake pedal	within 10 mm
Reasonable application range of brake friction pair	For single friction plate, the friction material shall remain at least 2mm The wear on each side of the brake disc shall be less than 1.5mm

General Technical Parameters

Recommended fluids

Item	Specification	Capacity
Engine lubricating oil, L	SAE 5W-30 ACEA C3 Long-life	6
Engine coolant, L	D-35(-35°C)	11
Cryogenic circulating coolant, L	D-35(-35°C)	4.5
Manual transmission fluid, L	Laike 75w/85	2.6
Brake fluid, L	Laike 901-4 DOT 4	1
Washer fluid, L	General low freezing point detergent	4
Air conditioning refrigerant, g	R1234yf	750±30(single A/C) 1100±30(dual A/C)

General Technical Parameters

Wheel and tire

Item	Parameter	
Wheel specification	6 1/2J×16 , 6J×16	
Tire size	215/75R16C	215/65R16C
Tire load index	116/114	109/107
Tire speed symbol	Not less than S (180 km/h)	Not less than T (190 km/h)
Vehicle type	VAN	VAN
Tire pressure of front/rear wheel (cold condition), bar	4.0/4.5	4.0/4.5
Tire pressure of spare wheel (cold condition), bar	4.5	4.5

General Technical Parameters

Wheel alignment parameters

Item		Parameter
Front Wheels	Camber	$0.067^{\circ} \pm 0.75^{\circ}$ Absolute value of difference between left and right wheels $\leq 0.75^{\circ}$
	Kingpin Caster	$2.1^{\circ} \pm 0.75^{\circ}$ Absolute value of difference between left and right wheels $\leq 0.75^{\circ}$
	Toe	$0.083^{\circ} \pm 0.083^{\circ}$ Absolute value of difference between left and right wheels $\leq 0.1^{\circ}$
	Kingpin Inclination	$12.6^{\circ} \pm 0.5^{\circ}$ Absolute value of difference between left and right wheels $\leq 0.5^{\circ}$
Rear Wheels	Toe	$0^{\circ} \pm 0.417^{\circ}$
	Camber	$0^{\circ} \pm 0.75^{\circ}$
	Rear Axle Thrust Angle	$0^{\circ} \pm 0.3^{\circ}$